

What to know when ordering TPI Air Circulators:

1. What is the operating voltage and phase?

- a. 120V (most common)
- b. 120V or 240V
- c. 277V
- d. 240 or 480V (offered in 3-phase)

2. How will you be mounting or operating this unit?

- a. Wall / Vertical Surface (Most Common)
- b. Floor – Pedestal Mount
- c. Pole Mount
- d. Ceiling
- e. Suspension Mount
- f. I-Beam Mount

3. What environment will this unit be operating in?

- a. Industrial – see TPI Series: HDH, IHP or ACH's
 - i. Dirty, dusty job sites or harsh industrial environment
 - ii. Wet, high moisture, or wash down rated environment
 - iii. Hazardous Location – Class I Group D, Class II Groups F & G
- b. Commercial – see TPI Series; CACU's
 - i. Clean areas or non-dusty environment

4. Will you need the fan head to rotate?

- a. Oscillating
- b. Non-Oscillating Fan Heads

5. Do you want to order assembled fan heads?

- a. Assembled Fan Head
- b. Unassembled Fan Head (ACU, UHP & CACU Series)

6. Do you have a color preference?

- a. Safety Yellow – HDH Series
- b. Industrial Textured Gray Finish (Most popular)
- c. Black Semi-Gloss Powder Coated Finish (CACU-Series)

Air Circulators - Motor Comparisons

Commercial Motors - Open Vent Motors

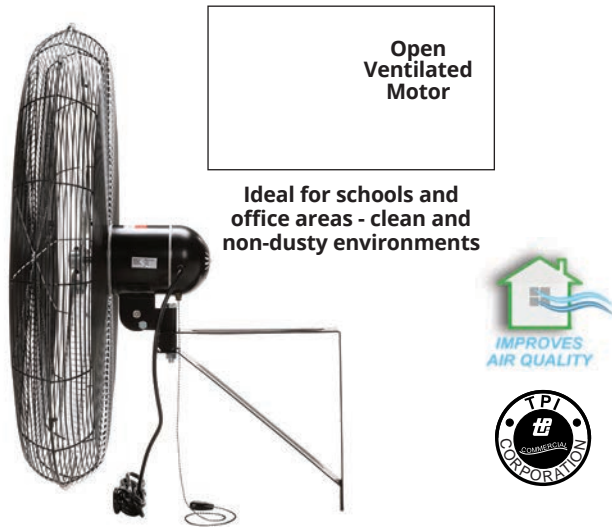

- Offered in ¼ HP & ½ HP
- Good output
- Open ventilated (air goes through the motor)
- Oscillating and non-oscillating
- Unassembled fan heads only
- 1-year limited warranty
- Ideal for commercial applications
 - offered in 120V models

Commercial Fan Applications

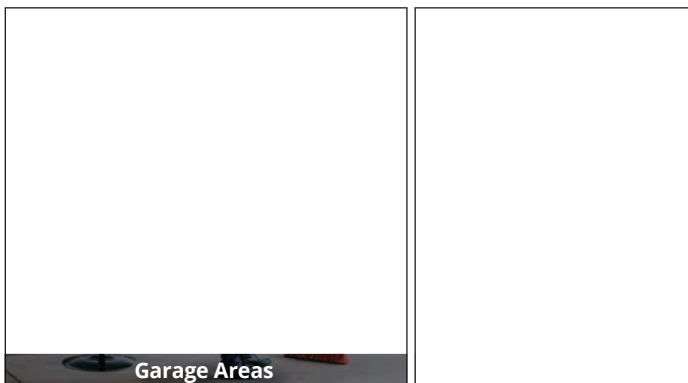

Industrial Motors -Totally Enclosed Motors (TEAO)



- Offered in ¼ HP, ½ HP & ¾ HP
- Higher quality and high CFP output
- Totally Enclosed Air Over (TEAO)
- Oscillating and non-oscillating
- Fully assembled fan heads
- No tools required to open grill assembly (retainer clips)
- 3-year warranty on ½ HP motors (5-year on ¾ HP)
- Ideal for commercial applications
 - offered in 120, 240, 277 & 480V models
 - washdown and hazardous location rated models

Industrial Fan Applications

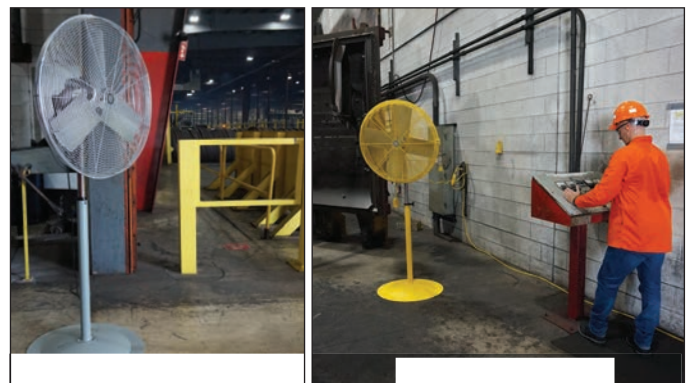

TPI Commercial Circulators



These circulators should be used in clean and dry commercial applications - such as schools, shops, offices or warehouses.

Commercial Circulators

Motor, blades, guards, and mount are packed and shipped in a single UPS-able carton.

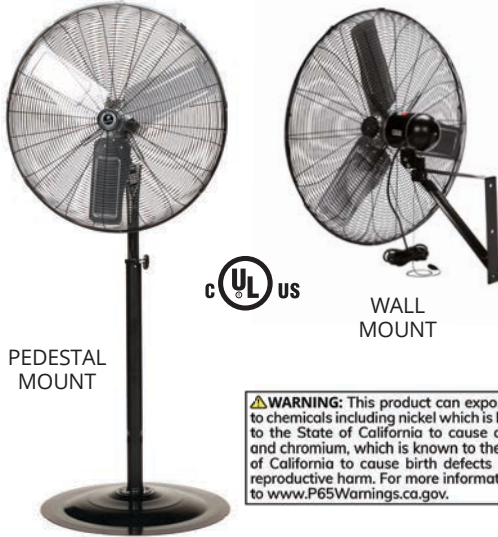

WARNING: This product can expose you to chemicals including nickel which is known to the State of California to cause cancer, and chromium, which is known to the State of California to cause birth defects and/or reproductive harm. For more information go to www.P65Warnings.ca.gov.

Features

- Black semi-gloss powder coated finish
- Pull chain switch
- SJT type 3 conductor, 9' long cord
- Coated steel guards with retaining clips
- Steel hub/spider aluminum paddle blades
- Pole adjusts center of fan from 43" to 60"
- Meets OSHA standards / 1-year limited warranty
- Imported to TPI specifications

Motor Specifications

- 1-phase
- 1/4 HP, 1/3 HP on HD models
- Ball bearing
- Open ventilated
- 120V
- 3 speeds
- Permanently lubricated
- Permanent split capacitor

Standard Non-Oscillating Models

MFG CATALOG NUMBER	MFG MODEL NUMBER	SIZE	HP	TYPE	MOUNT TYPE	CFM*			VELOCITY PROFILE	AMPS (HIGH)	WT. (lbs)
						HIGH	MED	LOW	CFM / AREA SQ FT		
08778002	CACU 20-P	20"	1/12	Non-Oscillating	Pedestal	1780	1600	1420	3300 / 125	1.38	52
08778102	CACU 20-W				Wall Mount						48
08706202	CACU 24-P	24"	1/8		Pedestal Mount	3400	3100	2800	5400 / 220	1.75	63
08706402	CACU 24-W				Wall Mount						43
08697402	CACU 30-P	30"	1/6		Pedestal Mount	4200	3800	3500	6700 / 240	1.93	66
08706302	CACU 30-W				Wall Mount						46
08761702	CACU 30-P-HD	30"	1/4	Pedestal Mount	5000	4600	4200	7000 / 250	3.60	56	

*Measured 2 feet from face of fan

Note: Stocked models may differ in appearance from photograph

TPI Commercial Oscillating Fans

Standard Oscillating Models



MFG CATALOG NUMBER	MFG MODEL NUMBER	SIZE	HP	TYPE	MOUNT TYPE	CFM*			VELOCITY PROFILE	AMPS			WT. (LBS)
						HIGH	MED	LOW	CFM / Area Sq Ft	HIGH	MED	LOW	
08748902	CACU 24-PO	24"	1/8	Oscillating	Pedestal Mount	3200	3000	2800	5100 / 230	1.75	1.26	1.15	68
08749102	CACU 24-WO				Wall Mount	3200	3000	2800	5100 / 230	1.75	1.26	1.15	48
08749002	CACU 30-PO	30"	1/6		Pedestal Mount	4200	3800	3500	6700 / 250	1.93	1.68	1.53	70
08749202	CACU 30-WO				Wall Mount	4200	3800	3500	6700 / 250	1.93	1.68	1.53	51
08761802	CACU 30-PO-HD	30"	1/4		Pedestal Mount	5000	4600	4200	7000 / 250	3.60	3.02	2.94	64

Notes:

*Measured 2 feet from face of fan
 Stocked models may differ in appearance from photograph - sizes are nominal
 Units imported to TPI specifications.



36", 42" & 48" TPI Commercial Belt Drive Portable Blowers



Features

- Rotary switch
- SJT type cord - 3 conductor - 8' long
- Aluminum 4-paddle blade
- Spiral wire front and rear guards
- Black powder coated 20 gauge steel housing
- Stationary non-swivel housing
- 5" rubber wheels
- Meets OSHA standards
- 1-year limited warranty
- Imported to TPI specifications

WARNING: This product can expose you to chemicals including nickel which is known to the State of California to cause cancer, and chromium, which is known to the State of California to cause birth defects and/or reproductive harm. For more information go to www.P65Warnings.ca.gov.

Motor Specification

- 2 speeds
- 120V
- Ball bearing
- 1-phase
- ODP type
- Permanently lubricated

Standard Models

MFG CATALOG NUMBER	MFG MODEL NUMBER	MOTOR HP	CFM*		VELOCITY PROFILE	MAX AMPS	WT. (lbs)
			HIGH	LOW	CFM / Area Sq Ft		
08734702	CPB 36-B	1/3	5,400	4,600	8600 / 300	4.20	82
08706602	CPB 42-B	1/3	7,600	6,700	12000 / 320	5.56	93
08722702	CPB 48-B	3/4	8,800	7,700	14000 / 500	7.95	129

*Measured 2 feet from face of fan

Note: Photograph is a representation of stocked models. Actual model may vary in appearance

24", 30", & 36" TPI Commercial Direct Drive Portable Blowers



Features

- Rotary or rocker switch
- SJT type cord - 3 conductor
- Spiral wire front and rear guards
- Black powder coated 20 gauge steel housing
- 5" rubber wheels
- Meets OSHA standards
- 1 year limited warranty
- Imported to TPI specifications

Motor Specification

- 2-speeds
- 120 Volt
- Ball bearing
- 1-phase
- Open ventilated
- Permanently lubricated

WARNING: This product can expose you to chemicals including nickel which is known to the State of California to cause cancer, and chromium, which is known to the State of California to cause birth defects and/or reproductive harm. For more information go to www.P65Warnings.ca.gov.

Standard Models

MFG CATALOG NUMBER	MFG MODEL NUMBER	BASE TYPE	MOTOR HP	CFM*		VELOCITY PROFILE	MAX AMPS	CORD LENGTH	SWITCH	BLADES	WT. (lbs)
				HIGH	LOW	CFM / Area Sq Ft					
08753502	CPB 30-D	Floor	1/5	4,400	3,800	6700 / 250	2.73	6'	Rocker	Aluminum	52
08710302	CPBS 30-D	Swivel	1/5	4,400	3,800	6700 / 250	2.73	6'	Rocker	Aluminum	60
08722602	CPB 36-D	Floor	1/3	5,400	4,600	8500 / 300	3.97	10'	Rotary	Steel	70
08770102	CPBS 24-DHV	Swivel	1/6	3,400	2,900	5400 / 240	2.35	9'	Rotary	Aluminum	38

*Measured 2 feet from face of fan

Note: Photograph is a representation of stocked models. Actual model may vary slightly in appearance

30", 36", & 42" TPI Industrial Direct Drive Portable Blowers



STANDARD MODEL



SWIVEL MODEL

Features

- Comes in sizes 30", 36", & 42"
- Rocker switch
- SJT type 3 conductor, 12' long cord
- Aluminum, 3 paddle blade
- Spiral, wire front and rear guards
- Corrosion and dent proof high density polyethylene housing
- 36" & 42" swivel model rotates 130° in 12 1/2° increments and locks in place with a steel locking pin
- Meets OSHA standards
- 1 Year limited warranty
- Made in U.S.A.



WARNING: This product can expose you to chemicals including nickel which is known to the State of California to cause cancer, and chromium, which is known to the State of California to cause birth defects and/or reproductive harm. For more information go to www.P65Warnings.ca.gov.

Motor Specifications

- 120V, 1-phase
- 30"- 1/4 HP 42"-1/2 HP
- Ball bearing
- Permanent split capacitor
- 2-speed on 30" & 36" model
- 1-speed on 42" model
- Permanently lubricated
- Totally enclosed

Standard Models

MFG CATALOG NUMBER	MFG MODEL NUMBER	FAN		WHEEL SIZE	MOTOR HP	CFM* / RPM		VELOCITY PROFILE CFM / Area Sq Ft	AMPS (HIGH)	WT. (lbs.)
		SIZE	TYPE			HIGH	LOW			
08211002	PBX 30-D	30"	STANDARD	8"	1/4	4400 / 1100	3800 / 950	7200 / 250	2.7	65
08213602	PBXS 30-D	30"	SWIVEL	10"		70				
08211102	PBX 36-D	36"	STANDARD	8"	1/3	6500 / 1040	5400 / 950	11500 / 320	5.5	82
08213702	PBXS 36-D	36"	SWIVEL	10"		110				
08211202	PBX 42-D	42"	STANDARD	10"	1/2	9,000 / 825		15000 / 340	7.9	102
08213802	PBXS 42-D	42"	SWIVEL	10"						128

*Measured 2 feet from face of fan

Note: Photograph is a representation of stocked models. Actual model may vary slightly in appearance

48" TPI Industrial Direct Drive Portable Blowers



WARNING: This product can expose you to chemicals including nickel which is known to the State of California to cause cancer, and chromium, which is known to the State of California to cause birth defects and/or reproductive harm. For more information go to www.P65Warnings.ca.gov.

Features

- Corrosion and dent proof high density polyethylene housing
- Rocker switch
- SJT type 3 conductor, 12' long cord
- Steel, 2 paddle blade
- Spiral, wire front and rear guards
- 10" wheels
- Swivel model rotates 130° in 12 1/2° increments and locks in place with a steel locking pin
- Meets OSHA standards
- 1-Year limited warranty
- Made in U.S.A.

Motor Specifications

- 1-phase
- 3/4 HP
- Ball bearing
- Permanent split capacitor
- 120V
- 1-speed
- Permanently lubricated
- Totally enclosed

Features

MFG CATALOG NUMBER	MFG MODEL NUMBER	SIZE	FAN TYPE	MOTOR HP	CFM* / RPM	VELOCITY PROFILE CFM / Area Sq Ft	AMPS (HIGH)	DIMENSIONS			WT. (lbs)
								"H"	"D"	"W"	
07997802	PB 48-D-OP	48"	STANDARD	3/4	11,800 / 825	14000 / 360	10.5	58.5	29	55.5	117
07998002	PBS 48-D-OP	48"	SWIVEL	3/4	11,800 / 825	14000 / 360	10.5	----	----	----	142

*Measured 2 feet from face of fan

Note: Photograph is a representation of stocked models. Actual model may vary slightly in appearance

36", 42", & 48" TPI Industrial Belt Drive Portable Blowers



STANDARD MODEL



WARNING: This product can expose you to chemicals including nickel which is known to the State of California to cause cancer, and chromium, which is known to the State of California to cause birth defects and/or reproductive harm. For more information go to www.P65Warnings.ca.gov.



SWIVEL MODEL



CORD WRAP INCLUDED WITH STANDARD MODEL

Features

- Comes in sizes 36", 42", and 48"
- Rocker switch on 120V, single phase models
- SJT-type 3-conductor, 12' long cord on 120V, single phase models/ no cord on dual voltage models
- 4-paddle blade: 36" PB / PBS & HL have Aluminium blades; 42" & 48" PB / PBS models have steel blades
- Spiral wire front and rear guards
- Corrosion and dent-proof high density Polyethylene housing
- 8" wheels (36" model), 10" wheels (42" & 48" models)
- Swivel model rotates 130° in 12.5° increments and locks in place with a steel locking pin
- External junction boxes on dual voltage models allow units to be wired for either voltage without removing guards
- Hazardous location models have explosion proof motors, metal housings, and external junction boxes rated for Class I, Group D and Class II, Groups E, F, & G
- Meets OSHA standards
- 1 year limited warranty
- Made in U.S.A.

Motor Specifications

- Single speed
- Permanently lubricated
- Ball bearing

Standard Models

MOTOR LISTING	SIZE	MOTOR				CFM**	VELOCITY PROFILE	STANDARD MODEL			SWIVEL MODEL		
		TYPE	HP	RPM	AMPS		CFM / Area Sq Ft	MFG CATALOG NUMBER	MFG MODEL NUMBER	WT. (lbs)	MFG CATALOG NUMBER	MFG MODEL NUMBER	WT. (lbs)
	36"	120 V 1 PH ODP	1/2	500	8.0	6,900	14000 / 360	08211402	PBX 36-B	120	08213302	PBXS 36-B	145
	42"		3/4	430	11.0	10,600	17500 / 420	08211502	PBX 42-B	135	08213402	PBXS 42-B	160
	48"		1	390	15.0	14,400	23500 / 550	08211602	PBX 48-B	155	08213502	PBXS 48-B	180
	36"	240/480 V 3 PH ODP	1/2	500	2.3 / 1.1	6,900	14000 / 360	08508602	PB 36-B-3	127	08509202	PBS 36-B-3	152
	42"		3/4	430	3.3 / 1.5	10,600	17500 / 420	08508702	PB 42-B-3	143	08509302	PBS 42-B-3	168
	48"		1	390	3.8 / 1.9	14,400	23500 / 550	08508802	PB 48-B-3	164	08509402	PBS 48-B-3	189
----	36"	120/240 V 1 PH EXP	1/2	500	7.8 / 3.9	6,900	14000 / 360	08508902	PB 36-B-HL*	135	08509502	PBS 36-B-HL	160
	42"		3/4	430	10.8 / 5.4	10,600	17500 / 420	08509002	PB 42-B-HL*	150	08509602	PBS 42-B-HL	175
	48"		1	390	13.2 / 6.6	14,400	23500 / 550	08509102	PB 48-B-HL*	173	08509702	PBS 48-B-HL	198

Note: Products listed in this section are custom built and subject to 100% cancellation/restocking charges.
 Note: Photograph is a representation of stocked models. Actual model may vary slightly in appearance.

*Models have no listing.

TPI Industrial Direct Drive Suspension Blowers



WARNING: This product can expose you to chemicals including nickel which is known to the State of California to cause cancer, and chromium, which is known to the State of California to cause birth defects and/or reproductive harm. For more information go to www.P65Warnings.ca.gov.

Features

- On-off rocker switch
- SJT type 3 conductor, 12' long cord
- Aluminum blade
- Powder coated spiral wire front and rear guards
- Corrosion and dent proof high density polyethylene housing
- Meets OSHA standards
- 1-year limited warranty
- Mounting chain not included
- Made in U.S.A.

Motor Specifications

- 120V, 1-phase
- Ball bearing
- Permanent split capacitor
- 2-Speed on 30" & 36" model
- 1-Speed on 42" model
- Permanently lubricated

Standard Models

SIZE	MOTOR HP	MFG CATALOG NUMBER	MFG MODEL NUMBER	CFM*		VELOCITY PROFILE	RPM HIGH	AMPS HIGH	WT. (lbs)
				HIGH	LOW	CFM / Area Sq Ft			
30"	1/4	08213002	SBX 30-D	4,400	3,800	7200 / 250	1050	2.7	58
36"	1/3	08213102	SBX 36-D	6,500	5,400	11500 / 320	1050	5.5	70
42"	1/2	08213202	SBX 42-D	9,000		15000 / 340	825	7.9	99

*Measured 2 feet from face of fan

TPI Industrial Belt Drive Suspension Blowers



WARNING: This product can expose you to chemicals including nickel which is known to the State of California to cause cancer, and chromium, which is known to the State of California to cause birth defects and/or reproductive harm. For more information go to www.P65Warnings.ca.gov.

Features

- On-off rocker switch on 120V, 1-Phase models
- SJT type 3 conductor, 12' long cord on 120V, 1-phase models
- No cord on dual voltage models
- Aluminum blade: SB 36-B, SB 36-B-HL, SB 42-B-HL, SB 48-B-HL
- Steel blade: SB 42-B, SB 48-B
- Corrosion and dent proof high density polyethylene housing
- Powder coated spiral wire front and rear guards
- Meets OSHA standards
- 1 year limited warranty
- Mounting chain not included
- Made in U.S.A.

Motor Specifications

- 120V, 1-phase
- Ball bearing
- Permanent split capacitor
- 2-speed on 30" & 36" model
- 1-speed on 42" model
- Permanently lubricated

External junction boxes on dual voltage models allow units to be wired for either voltage without removing guards.

Hazardous Location models have explosion proof motors and external junction boxes rated for Class I, Group D, & Class II, Groups E, F & G. (Metal housing and no switch)

Standard Models

MFG CATALOG NUMBER	MFG MODEL NUMBER	SIZE	MOTOR		CFM**	VELOCITY PROFILE	RPM	AMPS	WT. (LBS)
			TYPE	HP		CFM / Area Sq Ft			
08212702	SBX 36-B	36"	115 V, 1 PH, ODP	1/2	6,900	14000 / 360	500	8	120
08212802	SBX 42-B	42"		3/4	10,600	17500 / 420	430	11	135
08212902	SBX 48-B	48"		1	14,400	23500 / 550	390	15	155
08509802	SB 36-B-3	36"	230 / 460 V, 3 PH, ODP	1/2	6,900	14000 / 360	500	2.3 / 1.1	127
08509902	SB 42-B-3	42"		3/4	10,600	17500 / 420	430	3.3 / 1.5	143
08510002	SB 48-B-3	48"		1	14,400	23500 / 550	390	3.8 / 1.9	164
08510102	SB 36-B-HL*	36"	115 / 230 V, 1 PH, EXP	1/2	6,900	14000 / 360	500	7.8 / 3.9	135
08510202	SB 42-B-HL*	42"		3/4	10,600	17500 / 420	430	10.8 / 5.4	150
08510302	SB 48-B-HL*	48"		1	14,400	23500 / 550	390	13.2 / 6.6	173

Note: Products listed in this section are custom built and subject to 100% cancellation/restocking charges.

*Models have no listing. **Measured 2 feet from face of fan



FLOOR MODEL



YOKE MOUNTED MODEL



MBM-W
(Optional Wall/
Ceiling Mount)

WARNING: This product can expose you to chemicals including nickel which is known to the State of California to cause cancer, and chromium, which is known to the State of California to cause birth defects and/or reproductive harm. For more information go to www.P65Warnings.ca.gov.

Features

- Floor model or yoke mount models available
- Floor models have rotary switch
- Yoke mounted models have pull chain switch
- SJT type 3 conductor, 10' long cord
- Aluminum blade
- Spiral, wire front and rear guards
- For use in dirty or dusty environments
- Corrosion and dent proof high density polyethylene housing
- Bolt to any surface, or use with optional wall/ceiling mount.
- Meets OSHA standards
- 1 year limited warranty
- Made in U.S.A. with domestic and foreign components

Motor Specifications

- 1-phase
- 1/4 HP
- Ball bearing
- Totally enclosed
- 120V
- 2-speeds
- Permanently lubricated
- Permanent split capacitor

Standard Models

MFG CATALOG NUMBER	MFG MODEL NUMBER	FAN		CFM* / RPM		VELOCITY PROFILE CFM / Area Sq Ft	DIMENSIONS			AMPS (High)	WT. (LBS)
		TYPE	SIZE	HIGH	LOW		"H"	"W"	"D"		
08216302	MBX-24-DF	FLOOR STYLE	24"	3300 / 1140	2900 / 1070	5200 / 240	29 1/2"	28 1/2"	14 1/4"	1.8	52
08216502	MBX-24-DY	YOKE STYLE					29"	28 1/2"	14 1/4"		
08216402	MBX-30-DF	FLOOR STYLE	30"	4400 / 1040	3900 / 730	7000 / 250	38 1/2"	37 1/2"	14 1/2"	2.7	58
08216602	MBX-30-DY	YOKE STYLE					38"	37 1/2"	14 1/2"		
07989002	MBM-W	OPTIONAL WALL/CEILING MOUNT FOR YOKE STYLE MINI-BLOWER									4

*Measured 2 feet from face of fan

TPI Industrial Heavy Duty Square Belt Drive Portable Blowers



4" CASTERS



WARNING: This product can expose you to chemicals including nickel which is known to the State of California to cause cancer, and chromium, which is known to the State of California to cause birth defects and/or reproductive harm. For more information go to www.P65Warnings.ca.gov.

Features

- On-off rocker switch
- SJT type 3 conductor, 12' long cord
- Steel blade
- Permanently lubricated bearings on blade drive shaft
- Powder coated front and rear guards
- Powder coated 20 gauge venturi
- 18 gauge galvanized steel housing
- Meets OSHA standards / 1 year limited warranty
- Made in U.S.A.

Motor Specifications

- 1-phase
- Ball bearing
- Drip-proof motor
- 120V
- Single speed
- Permanently lubricated
- 1/2" shaft

Standard Models

SIZE	MFG CATALOG NUMBER	MFG MODEL NUMBER	MOTOR			CFM*	VELOCITY PROFILE CFM / Area Sq Ft	DIMENSIONS			WT. (LBS)
			HP	RPM	AMPS			"H"	"W"	"D"	
36"	08683602	PCBT 36-B	1/2	1725	8.0	6,900	14,000 / 360	48.25"	40.38"	22.50"	120
42"	08683702	PCBT 42-B	3/4		11.0	10,600	17,500 / 420	56.50"	48.38"	22.50"	140
48"	08683802	PCBT 48-B	1		15.0	14,400	23,500 / 550	62.50"	54.38"	18.50"	185

*Measured 2 feet from face of fan

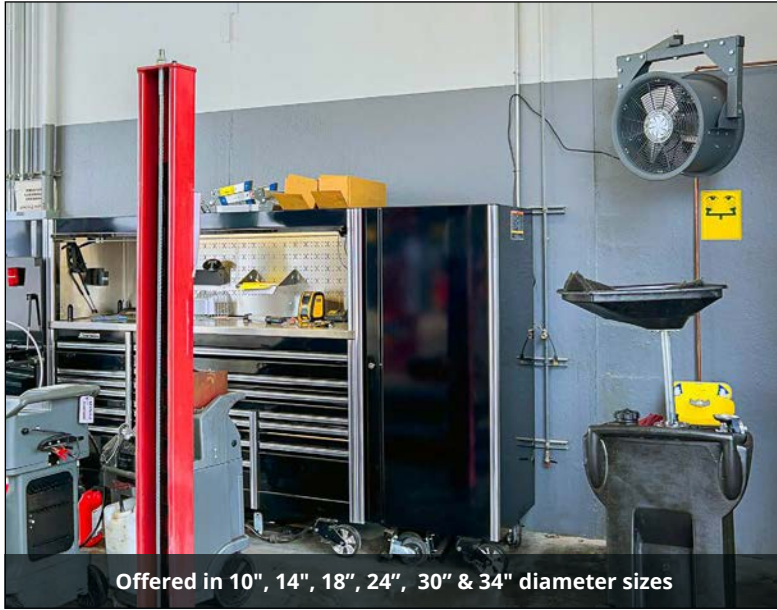

Offered in 10", 14", 18", 24", 30" & 34" diameter sizes

Features

- ETL C/US listed for indoor spot cooling applications
- All steel construction housing with gray epoxy powder coated finish
- Heavy-duty yoke mounting bracket design with 2" square steel tubing frame
- Direct drive Totally Enclosed Air-Over (TEAO) motor generating up to 15,000-CFM's
- Aluminum 3-paddle blade system with steel hub and cast aluminum spider connections
- Built-in rotating design allows the supplied mounting bracket to pivot 120° in (9) adjustment settings at 15° variations.
- Single and three phase options available
- All units are shipped fully assembled and ready for hard-wired connections
- 2-year motor warranty

Specifications 10" - 30" Models

- 1-speed
- 1 phase, 120V, 208/240V, 277V or 480V
- 3-phase, 480V
- Ball bearing
- Totally enclosed, air over motor 60 Hz
- Permanent split capacitor/lubricated
- ½" motor shaft
- Class B, 1/4, 1/2 or 1-HP



Benefits

- Housing designed for all types of air circulating applications to provide directional – high velocity air flow.
- Built-in rotating design allows the supplied mounting bracket to pivot 120° in (9) adjustment settings at 15° variations.
- Front & rear spiral wound grills are OSHA approved and have a black powder coated finish.
- All units are shipped fully assembled and ready for hard-wired connections
- TEAO motor has a Class B rating, with automatic thermal protection and ball bearing design for harsh environments; rated up to 115°F max. ambient temp.
- Single and three phase options available in 120, 277 & 480-Volt.

Specifications 34" Models

- 1-speed
- 3 phase, 208-230/460V
- Field convertible
- Ball bearing
- Totally enclosed, air over motor 60 Hz
- 1150 RPM, Regreasable
- Class F, 3HP
- Requires field provided overload protection



HV34

Applications

Units are ideal for warehouse, material handling, and high-shelf areas for directing high volumes of air flow down aisles, loading dock areas, conveyor systems, processing centers, workstations, job site, and all types of industrial operations for rugged environments.

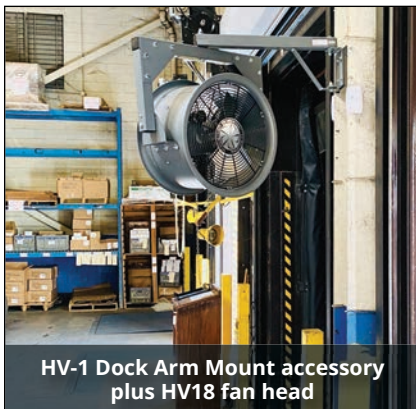

HV-1 Dock Arm Mount accessory plus HV18 fan head

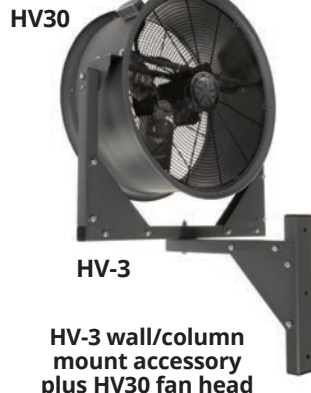

HV30

HV-3

HV-3 wall/column mount accessory plus HV30 fan head

Standard Models

SIZE	MFG CATALOG NUMBER	MFG MODEL NUMBER	VOLTS	PH	AMPS (High)	HP	WATTS	RPM	CFM	VELOCITY PROFILE	BLADE DIA.	DIMENSIONS (in.)			WT. (lbs.)
										CFM/Area Sq. Ft.		L	W	H	
10"	08220502	HV10-120V	120	1	2.5	1/4	186.5	3400	989	1582 / 100	8"	13.4	15.7	19.5	25
	08220602	HV10-208/240V	208/240	1	1.3/1.2	1/4	186.5	3400	989	1582 / 100	8"	13.4	15.7	19.5	25
	08220702	HV10-277V	277	1	1.0	1/4	186.5	3400	989	1582 / 100	8"	13.4	15.7	19.5	25
	08220802	HV10-480V	480	1	0.62	1/4	186.5	3400	989	1582 / 100	8"	13.4	15.7	19.5	25
14"	08220902	HV14-120V	120	1	2.5	1/4	186.5	3400	1732	2771 / 125	12"	14.4	19.7	21.1	32
	08221002	HV14-208/240V	208/240	1	1.3/1.2	1/4	186.5	3400	1732	2771 / 125	12"	14.4	19.7	21.1	32
	08221102	HV14-277V	277	1	1.0	1/4	186.5	3400	1732	2771 / 125	12"	14.4	19.7	21.1	32
	08221202	HV14-480V	480	1	0.62	1/4	186.5	3400	1732	2771 / 125	12"	14.4	19.7	21.1	32
18"	08195602	HV18-120V	120	1	3.4	1/2	373	1725	3000	5000 / 175	16"	13.5	23.8	25.9	45
	08195702	HV18-208/240V	208/240	1	1.9	1/2	373	1725	3000	5000 / 175	16"	13.5	23.8	25.9	45
	08195802	HV18-277V	277	1	1.5	1/2	373	1725	3000	5000 / 175	16"	13.5	23.8	25.9	45
	08195902	HV18-480V	480	1	1.0	1/2	373	1725	3000	5000 / 175	16"	13.5	23.8	25.9	45
	08197202	HV18-480V-3	208-230/460	3	1.4 / 0.8	1/2	373	1725	3000	5000 / 175	16"	13.5	23.8	25.9	45
24"	08196002	HV24-120V	120	1	3.8	1/2	373	1725	5290	8500 / 275	22"	13.5	29.5	31.2	45
	08196102	HV24-208/240V	208/240	1	2.1	1/2	373	1725	5290	8500 / 275	22"	13.5	29.5	31.2	58
	08196202	HV24-277V	277	1	1.7	1/2	373	1725	5290	8500 / 275	22"	13.5	29.5	31.2	58
	08196302	HV24-480V	480	1	1.1	1/2	373	1725	5290	8500 / 275	22"	13.5	29.5	31.2	58
	08197302	HV24-480V-3	208-230/460	3	1.5 / 0.8	1/2	373	1725	5290	8500 / 275	22"	13.5	29.5	31.2	58
30"	08196402	HV30-120V	120	1	7.6	1	746	1700	9000	14250 / 375	28"	16	38.9	39	58
	08196502	HV30-208/240V	208/240	1	4.3	1	746	1700	9000	14250 / 375	28"	16	38.9	39	85
	08196602	HV30-277V	277	1	3.2	1	746	1700	9000	14250 / 375	28"	16	38.9	39	85
	08196702	HV30-480V	480	1	1.6	1	746	1700	9000	14250 / 375	28"	16	38.9	39	85
	08197402	HV30-480V-3	208-230/460	3	3.4 / 1.6	1	746	1700	9000	14250 / 375	28"	16	38.9	39	85
34"	08221402	HV-34-480V-3	208-230/460	3	10.1 / 5.1	3	2207	1150	15000	23500 / 525	32"	24.75	42.26	44.94	227

HV-1 Dock Swing Arm
24" reach



Wall or Column Mount
HV-2 (22" reach)
HV-3 (25" reach)



Accessory Models

MFG CATALOG NUMBER	MFG MODEL NUMBER	TYPE	FITS MODEL SERIES
08197502	HV-1	Dock Arm, 24" Reach	HV10 - HV18
08197602	HV-2	Wall / Column Mount	HV10-HV24
08197702	HV-3		HV10-HV30
08221602	HV-3-34		HV34
08199002	HV-4-18	Low Stand	HV18
08199102	HV-4-24		HV24
08199202	HV-4-30		HV30
08221502	HV-4-34		HV34
08199302	HV-5-18	Medium Stand	HV18
08199402	HV-5-24		HV24
08199502	HV-5-30		HV30
08199602	HV-6-18	High Stand	HV18
08199702	HV-6-24		HV24
08199802	HV-6-30		HV30
08199902	HV-7-DC-1	Disconnect Switch	1-Phase
08200002	HV-7-DC-3		3-Phase
08209802	HV8	Caster Kit (Qty.4)	ALL Heads/Stands



Image Shown Includes:
HV24 (Fan Head)
HV-5-24 (Medium Stand)
HV8 (Caster Kit)

Note: All items must be ordered separately.

Note: Stands DO NOT include casters
Contact TPI Customer Service for additional cost for mounting fan to the stand and wiring the disconnect prior to shipping.

TPI Industrial Heavy Duty Direct Drive Blowers

WARNING: This product can expose you to chemicals including nickel which is known to the State of California to cause cancer, and chromium, which is known to the State of California to cause birth defects and/or reproductive harm. For more information go to www.P65Warnings.ca.gov.



LOW STAND

MEDIUM STAND

HIGH STAND

Features

- Totally enclosed and explosion proof motors
- Explosion proof motors are Class 1, Div 1, Group D Class 2, Div 1, Groups F & G
- Cast Aluminum props
- 14 gauge steel body and stand
- Acid resistant coating available
- Baked enamel coating
- 360° swivel on high and medium stand units
- Meets federal OSHA requirements
- 1 year limited warranty

NOTE:

- **Single phase motors are field convertible 115V / 230V**
- **Three phase motors are field convertible 230V / 460V**
- **Motors are set to lower voltage at the factory unless a request is made at time of order to set to the higher voltage**

Standard Models

SIZE	MFG MODEL NUMBER	HP	RPM	CFM	DB's @ 10'	WT. (LBS)		
						STAND		
						LOW	MED	HIGH
MODEL NUMBER SUFFIXES								
18"	MCD18-1/4	1/4	1725	3050	74	103	145	210
	MCD18-1/3	1/3	1725	3450	76	105	150	215
	MCD18-1	1	1725	4600	77	117	165	230
24"	MCD24-1/4	1/4	1725	5200	80	115	165	230
	MCD24-1/3	1/3	1140	5300	74	126	175	250
	MCD24-1/2	1/2	1725	6000	80	120	170	240
	MCD24-3/4	3/4	1140	6900	74	140	190	260
	MCD24-1	1	1725	7400	82	130	180	250
	MCD24-1 1/2	1.5	1725	8200	84	137	190	255
	MCD24-3	3	1725	10500	87	160	210	270
30"	MCD30-1/3	1/3	1140	6900	80	150	205	260
	MCD30-1/2	1/2	1725	8900	86	141	195	250
	MCD30-3/4	3/4	1140	10400	80	210	260	320
	MCD30-1	1	1140	11200	81	200	260	310
	MCD30-1 1/2	1.5	1725	12000	92	200	250	310
	MCD30-2	2	1140	14000	84	225	270	330
36"	MCD30-3	3	1725	16000	94	220	265	325
	MCD36-1	1	1140	13000	82	250	320	375
	MCD36-1 1/2	1.5	1725	14850	88	250	320	375
	MCD36-2	2	1140	17500	82	255	325	380
	MCD36-3	3	1725	18500	90	260	330	390
42"	MCD36-5	5	1725	23000	94	260	330	390
	MCD42-2	2	1140	19500	85	315	415	565
	MCD42-5	5	1725	27000	98	320	420	570
48"	MCD48-5	5	1140	32000	92	500	620	710
	MCD48-7 1/2	7.5	1140	37000	105	625	745	835
	MCD48-10	10	1140	41000	105	682	800	890
60"	MCD60-3	3	690	35000	87	690	855	965
	MCD60-5	5	690	45000	87	730	895	1005
	MCD60-7 1/2	7.5	870	47000	90	945	1110	1220
	MCD60-10	10	870	57200	91	1035	1200	1310
	MCD60-15	15	870	60750	92	1080	1245	1355

Manual Starter Switches

MFG MODEL NUMBER		H.P. RATING
1 PH	3 PH	
SW-1/4	SW-1/4-3	1/4-1/3
SW-1/2	SW-1/2-3	1/2-3/4
SW-1	SW-1-3	1
SW-1 1/2	SW-1 1/2-3	1.5
----	SW-2-3	2
----	SW-3-3	3
----	SW-5-3	5
----	SW-7 1/2-3	7.5

Polyolifin Casters

MFG MODEL NUMBER	FAN SIZE	WHEEL SIZE	WT. (LBS)
CAS - 18	18" - 30"	4"	10
CAS - 48	36" - 48"	5"	14

(FOR LOW & MEDIUM STAND)
4 CASTERS - 2 LOCKING

Note: Products listed in this section are custom built and subject to 100% cancellation/restocking charges

TPI Industrial Heavy Duty Permanent Mount Direct Drive Blowers



1-WAY SWIVEL

2-WAY SWIVEL



⚠ WARNING: This product can expose you to chemicals including nickel which is known to the State of California to cause cancer, and chromium, which is known to the State of California to cause birth defects and/or reproductive harm. For more information go to www.P65Warnings.ca.gov.

Features

- Front and rear spiral guards
- Explosion proof motors are Class 1, Div 1, Group D and Class 2, Div 1, Groups F & G
- Cast Aluminum props
- 14 gauge steel body and stand
- Meets federal OSHA requirements
- 1 year limited warranty

NOTE:

- **Single Phase motors are field convertible 115V / 230V**
- **Three Phase motors are field convertible 230V / 460V**
- **Motors are set to lower voltage at the factory unless a request is made at time of order to set to the higher voltage**

Standard Models

BLADE SIZE	MFG MODEL NUMBER	HP	RPM	CFM	DB'S @ 10'	WT. (LBS)	
						1-WAY SWIVEL	2-WAY SWIVEL
MODEL NUMBER SUFFIXES							
18"	MCD18-1/4	1/4	1725	3050	74	130	140
	MCD18-1/3	1/3	1725	3450	76	135	145
	MCD18-1	1	1725	4600	77	145	155
24"	MCD24-1/4	1/4	1725	5200	80	145	155
	MCD24-1/3	1/3	1140	5300	74	155	165
	MCD24-1/2	1/2	1725	6000	80	150	160
	MCD24-3/4	3/4	1140	6900	74	170	180
	MCD24-1	1	1725	7400	82	160	170
	MCD24-1 1/2	1.5	1725	8200	84	165	175
	MCD24-3	3	1725	10500	87	190	200
30"	MCD30-1/3	1/3	1140	6900	80	180	190
	MCD30-1/2	1/2	1725	8900	86	170	180
	MCD30-3/4	3/4	1140	10400	80	240	250
	MCD30-1	1	1140	11200	81	230	240
	MCD30-1 1/2	1.5	1725	12000	92	230	240
	MCD30-2	2	1140	14000	84	255	265
36"	MCD30-3	3	1725	16000	94	250	260
	MCD36-1	1	1140	13000	82	295	305
	MCD36-1 1/2	1.5	1725	14850	88	295	305
	MCD36-2	2	1140	17500	82	300	310
	MCD36-3	3	1725	18500	90	315	325
	MCD36-5	5	1725	23000	94	305	315

Exhaust Ventilation Guide

Minute air change chart for Commercial and Industrial Applications

Place	Typical	Range
Assembly	(6)	2-10
Auditoriums	(6)	1-20
Bakeries	(2)	1-3
Banks	(6)	3-10
Bars	(4)	2-5
Barns	(15)	10-20
Boiler Rooms	(2)	1-3
Bowling Alley	(3)	1-5
Cafeteria	(4)	3-5
Churches	(6)	2-10
Classrooms	(6)	4-8
Compressor Rooms	(2)	1-3
Dance Halls	(6)	2-10
Dairies	(4)	2-5
Dormitories	(6)	4-8
Dry Cleaning Plant	(3)	1-5

CFM Required for Ventilation =

Place	Typical	Range
Engine Rooms	(3)	1-5
Factories	(7)	4-10
Foundries	(5)	2-8
Garages	(7)	4-10
Generating Plants	(4)	2-5
Glass Plants	(2)	1-3
Gymnasiums	(6)	2-10
Hallways	(8)	4-12
Kitchens (Comm.)	(3)	1-5
Laboratories	(3)	1-5
Libraries	(4)	2-5
Laundries	(2)	1-3
Locker Rooms	(6)	2-10
Machine Shops	(4)	2-5
Markets	(6)	2-10

$\frac{\text{Building Cubic Feet}}{\text{Minutes Per Air Change}}$

Place	Typical	Range
Mills	(4)	2-5
Packing Houses	(4)	3-5
Plants	(7)	4-10
Plating Plants	(4)	2-5
Print Shops	(7)	4-10
Restaurants	(6)	2-10
Rest Rooms	(7)	4-10
Schools	(7)	4-10
Stores	(7)	4-10
Theaters	(6)	4-8
Transformer Rooms	(3)	1-5
Turbine Rooms	(4)	2-5
Waiting Rooms	(12)	10-15
Warehouses	(7)	4-10
Welding Rooms	(3)	1-4

Note: Products listed in this section are custom built and subject to 100% cancellation/restocking charges

Industrial Workstation Floor Fans



Features

- Steel construction with a silver & black powder coated finish
- Direct drive totally enclosed air-over (TEAO) motor generating up to 6000-CFM's (F24-TE-HV)
- Three-speed, 120V, 1/8, 1/4, or 1/12-HP, sleeve bearing, permanently lubricated, TEAO motor operates at 60HZ and 1660-RPMs
- Rotary switch located on the back grill
- 10' long SJT-type grounded 3-conductor cordset with molded plug
- Aluminum 3-paddle blade system with steel hub and cast aluminum spider connections
- 1-year manufacturer's warranty

WARNING: This product can expose you to chemicals including nickel which is known to the State of California to cause cancer, and chromium, which is known to the State of California to cause birth defects and/or reproductive harm. For more information go to www.P65Warnings.ca.gov.



Motor Specifications

- Sleeve bearing
- Totally enclosed
- 1-phase, 120V
- 3-speed
- Permanently lubricated
- Frame size: 42
- 5/16 shaft

SIZE	MFG CATALOG NUMBER	MFG MODEL NUMBER	FAN TYPE	MOTOR HP	CFM** / RPM			VELOCITY PROFILE CFM / Area Sq Ft	DIMENSIONS			MAX AMPS	WT. (lbs)
					HIGH	MED	LOW		"H"	"W"	"D"		
12"	07986102	F-12-TE	FLOOR MODEL	1/12	900 / 1590	800 / 1380	700 / 1080	1400 / 50	15 1/4"	14 1/2"	9 1/2"	1.1	13
18"	07972902	F-18-TE		1/8	1800 / 1660	1500 / 1550	1300 / 1370	2900 / 125	20 1/2"	20 1/2"	10 1/2"	2.2	20
24"	08528502	F-24-TE		1/8	2100 / 1634	1900 / 1484	1600 / 1200	3500 / 150	26"	26"	10 1/2"	2.4	23
24"	08775402	F-24-TE-HV		1/4	3800 / 1100	3600 / 950	3400 / 800	6000 / 240	26"	26"	10 1/2"	2.7	25
18"	07973002	F-18H-TE*	HIGH STAND	1/8	1800 / 1660	1500 / 1550	1300 / 1370	2900 / 125	53"	25"	27"	2.2	27
24"	08540602	F-24H-TE*		1/8	2100 / 1634	1900 / 1484	1600 / 1200	3500 / 150	53"	30"	27"	2.4	30

**Measured 2 feet from face of fan

*Made in U.S.A. with domestic and foreign components.

WARNING: This product can expose you to chemicals including nickel which is known to the State of California to cause cancer, and chromium, which is known to the State of California to cause birth defects and/or reproductive harm. For more information go to www.P65Warnings.ca.gov.



*Measured 2 feet from face of fan

Industrial Mounted Workstation Fans



FAN SIZE	DIMENSIONS		
	"H"	"W"	"D"
12"	15 1/4"	14 1/2"	9 1/2"
18"	21 1/2"	20 1/2"	10 1/2"
24"	27"	26"	10 1/2"

Features

- Pull chain switch
- Head rotates 360° vertically and horizontally
- Coated steel guards
- SJT type 3 conductor, 10' long cord
- Steel hub/spider aluminum paddle blades
- Meets OSHA standards / 1 Year limited warranty
- Imported to TPI specifications



Motor Specifications

- Sleeve bearing
- Totally enclosed, permanently lubricated
- Frame size: 42"
- 3-speed
- 1-phase, 120V
- 5/16" (12" fan only) and 1/2" shaft

Standard Models

FAN SIZE	MFG CATALOG NUMBER	MFG MODEL NUMBER	MOTOR HP	CFM* / RPM			VELOCITY PROFILE	MAX AMPS	WT. (lbs)
				HIGH	MED	LOW	CFM / Area Sq Ft		
12"	07986002	U-12-TE	1/12	900 / 1590	800 / 1380	700 / 1080	1400 / 50	1.1	13
18"	07972802	U-18-TE	1/8	1800 / 1660	1500 / 1550	1300 / 1370	2900 / 125	2.2	20
24"	08540702	U-24-TE	1/8	2100 / 1634	1900 / 1484	1600 / 1200	3500 / 150	2.4	23
24"	08775502	U-24-TE-HV	1/4	3800 / 1100	3600 / 950	3400 / 800	6000 / 240	2.7	25

Pipe Mount Adaptor

PIPE DIAMETER	MFG CATALOG NUMBER	MFG MODEL NUMBER
1"	08512402	PM-1
1 1/2"	08512502	PM-1.5
2"	08512602	PM-2
2 1/2"	08512702	PM-2.5
3"	08512802	PM-3

*Measured 2 feet from face of fan

FAN SIZE	MFG CATALOG NUMBER	MFG MODEL NUMBER	MOTOR HP	CFM* / RPM			MAX AMPS	DESCRIPTION
				HIGH	MED	LOW		
12"	08216102	U-12-TE-W	1/12	900/1590	800/1380	700/1080	1.1	12" Industrial Mounted Workstation Fan w/ Mounting Arm
18"	08216202	U-18-TE-W	1/8	1800/1660	1500/1550	1300/1370	2.2	18" Industrial Mounted Workstation Fan w/ Mounting Arm



U-18-TE-W

MFG CATALOG NUMBER	MFG MODEL NUMBER	DESCRIPTION
08215902	WCM-W-10	WORKSTATION MOUNTING ARM, 6" - 10"
08216002	WCM-W-14	WORKSTATION MOUNTING ARM, 10" - 14"

Outdoor Rated Yoke Mount Fans



Features

- Direct drive totally enclosed motor
- Pull chain switch
- Head rotates 360° vertically and horizontally
- Knobs allow for 180° vertical rotation
- Coated black finish steel guards
- Steel yoke mounting bracket
- All black finish with aiming handle
- SJT type 3 conductor, 10' long cord
- Steel hub/spider aluminum 3-paddle blades
- Meets OSHA standards / 1 year limited warranty
- Imported to TPI specifications

Motor Specifications

- Sleeve bearing
- Totally enclosed, permanently lubricated
- Frame size: 42"
- 3-speeds
- 1-phase, 120V
- 1/2" shaft

Standard Models

FAN SIZE	MFG CATALOG NUMBER	MFG MODEL NUMBER	MOTOR HP	RPM	CFM			VELOCITY PROFILE	MAX AMPS	WT. (lbs)
					HIGH	MED	LOW	CFM/Area Sq. Ft.		
18"	08194502	U-18-TE-HD	1/10	1625	1900	1500	1300	3100 / 125	1.1	20
24"	08211802	U-24-TE-HD	1/4	1625	3800	3600	3400	6000 / 240	2.4	28

*Measured 2 feet from face of fan



CF-20



Features

- Rotary switch
- SJT type cord - 3 conductor - 7' long
- Aluminum blade
- Coated steel guards with retaining clips
- Meets OSHA standards / 1 year limited warranty
- Imported to TPI specifications

Motor Specification

- 3-speed
- 120V
- Sleeve bearing
- 1-phase
- Open ventilated
- Permanently lubricated

WARNING: This product can expose you to chemicals including nickel which is known to the State of California to cause cancer, and chromium, which is known to the State of California to cause birth defects and/or reproductive harm. For more information go to www.P65Warnings.ca.gov.

Standard Models

MFG CATALOG NUMBER	MFG MODEL NUMBER	SIZE	TYPE	MOTOR HP	CFM			MAX AMPS	WT. (LBS)
					HIGH	MED	LOW		
08723002	CF-12	12"	FLOOR	1/30	1050	875	750	0.48	10
08723102	CF-18	18"	FLOOR	1/16	1600	1480	1380	1.15	16
08706502	CF-20	20"	FLOOR	1/12	1725	1600	1480	1.21	18

Note: Units should be used in clean, dry, commercial applications.

Note: Photograph is a representation of stocked models. Actual model may vary in appearance.

Workstation Oscillating Office Fans

Features

- 3-speed oscillating fans with push button controls
- 3-conductor, SPT cord & plug
- White powder coated wire mesh guards
- White plastic housing and blade
- Stand fan extends to 40" height
- Meets OSHA standards / 1 year limited warranty
- Imported to TPI specifications

WARNING: This product can expose you to chemicals including nickel which is known to the State of California to cause cancer, and chromium, which is known to the State of California to cause birth defects and/or reproductive harm. For more information go to www.P65Warnings.ca.gov.



STAND FAN



DESK FAN



Standard Models

SIZE	MFG CATALOG NUMBER	MFG MODEL NUMBER	FAN TYPE	SPEEDS	CFM HIGH	AMPS HIGH	WT. (lbs)
12"	08513002	ODF-12	DESK	3	860	0.4	5.4
16"	08513102	ODF-16	DESK	3	1530	0.5	8.5
16"	08513202	OSF-16	STAND	3	1530	0.5	15.5

Workstation Wall Mount Fan With Pivoting Arm

18" HIGH VELOCITY FAN MOUNTED ON 24", 40", or 60" PIVOTING ARMS



WARNING: This product can expose you to chemicals including nickel which is known to the State of California to cause cancer, and chromium, which is known to the State of California to cause birth defects and/or reproductive harm. For more information go to www.P65Warnings.ca.gov.

Mounting Arm Features

- 1 1/2" square, 14 gauge, steel tubing
- 3" x 5" x 3/16" mounting plate attaches with (4) 3/8" bolts
- 5' long, 18/3 SJWT conductor cord and NEMA 5-15 grounded plug
- Dual electrical outlets embedded in arm to allow connection of modular fan and optional light
- Made in U.S.A. with domestic and foreign components

Modular Fan Features

- 18" high velocity circulator, with 3 speed, 1/8 HP, 115V, 1-Phase permanently lubricated, totally enclosed, PSC motor
- Modular fan plugs into electrical outlet on arm
- Coated steel guards / Aluminum blades
- Meets OSHA standards / 1 year limited warranty
- Use on loading docks to cool off workers entering hot truck trailers.
- Use at factory workstations to cool off people or the machines.

Standard Models

MFG CATALOG NUMBER	MFG MODEL NUMBER	FAN SIZE	ARM LENGTH	FAN CFM*			VELOCITY PROFILE	MAX AMPS	WT. (lbs)
				HIGH	MED	LOW	CFM / Area Sq Ft		
08009102	24-LDF-TE	18"	24"	1800	1500	1300	2900 / 125	2.2	31
08009202	40-LDF-TE	18"	40"						38
08009302	60-LDF-TE	18"	60"						44

*Measured 2 feet from face of fan

Loading Dock Arm Fan

MFG CATALOG NUMBER	MFG MODEL NUMBER	FAN SIZE	FAN CFM*			MAX AMPS	WT. (lbs)
			HIGH	MED	LOW		
07971802	LDF-18-TE	18"	1800	1500	1300	2.2	20

Optional Modular Lights



DKL-INC



Light Features

- Plugs into embedded outlet in arm
- On/off switch and wire guard included
- LED bulb included with DKLED-30W-SP
- Safety yellow finish for higher visibility

Standard Models

WARNING: This product can expose you to chemicals including nickel which is known to the State of California to cause cancer, and chromium, which is known to the State of California to cause birth defects and/or reproductive harm. For more information go to www.P65Warnings.ca.gov.

MFG CATALOG NUMBER	MFG MODEL NUMBER	LIGHT HEAD TYPE	MAX WATTS	MAX LUMENS	AVE. BULB LIFE (HRS)	WT. (lbs)
04465602	DKL-INC	Incandescent	300	3,700	2,000	5

Low Velocity "Special Application" Workstation Fan



WALL MOUNT

WARNING: This product can expose you to chemicals including nickel which is known to the State of California to cause cancer, and chromium, which is known to the State of California to cause birth defects and/or reproductive harm. For more information go to www.P65Warnings.ca.gov.

Features

- 12" aluminum blade air circulator for wall, ceiling, or bench mount
- 120V, 1-phase, 1/12 HP with direct wire electrical connection
- Toggle switch with 2-speed control generating up to 1200 CFM
- All metal construction with a gray powder coated finish
- Fan head tilts 90° in horizontal and vertical plane
- Conforms to U.S. Navy Specification MIL-DTL-68G
- Meets OSHA standards / 1-year limited warranty
- Made in the U.S.A. with domestic and foreign components



BENCH MOUNT

CEILING MOUNT

Standard Models

SIZE	MFG CATALOG NUMBER	MFG MODEL NUMBER	MOTOR HP	CFM* / RPM		VELOCITY PROFILE	AMPS HIGH	WT. (lbs)
				HIGH	LOW	CFM / Area Sq Ft		
12"	08708902	N-12	1/12	800 / 1350	600 / 1000	1200 / 40	0.6	12

*Measured 2 feet from face of fan

Features

- 120-Volt / single phase, 60HZ electrical service
- Permanently sealed ball bearing brushless DC motor provides maintenance free and quiet operation
- Low energy consumption – high efficiency performance
- White powder coated finish on steel motor housing & downrod
- White polymer 3-paddle blade system designed for quiet operation
- Includes 24" stainless steel safety cable kit
- Easy to mount to the supplied steel J-Hook connection
- Satisfies the U.S. Department of Energy's "Energy Guide" requirements
- Forward and reverse available when used with optional speed controller to provide year round operation. (E56-CF-D & E60-CF-D)
- E60-CFC-D has 5 speeds, includes cord/controller & IP65 rated equivalent for wet locations
- ETL Listed for USA & Canada / 5-year limited warranty



forward/reverse wiring options



Model: E60-CFC-D
Indoor / Outdoor Rated
Plug & Play Install
Includes Speed Controller



Motor Specifications

	Model #	Amps	Watts
• 1-Phase, 120V	E-56CF-D	0.46	30
• Permanent sealed	E-60CF-D	0.46	30
• Brushless DC motor	E-60CFC-D	0.46	30
• Energy Consumption	E-60CFC-D	0.46	30

WARNING: This product can expose you to chemicals including nickel which is known to the State of California to cause cancer, and chromium, which is known to the State of California to cause birth defects and/or reproductive harm. For more information go to www.P65Warnings.ca.gov.



Standard Models

MFG CATALOG NUMBER	MFG MODEL NUMBER	BLADE DIAMETER	AIRFLOW OPTIONS	DOWNROD LENGTH	MAX CFM	MOTOR RPM	MOTOR TYPE	CORD INCLUDED	SPEED CONTROLLER	WEIGHT (lbs.)
08220002	E-56CF-D	56"	Forward/Reverse	18"	6858	255	Moisture Rated	None	Sold Separately	15.7
08220102	E-60CF-D	60"	Forward/Reverse	18"	7234	240	Moisture Rated	None	Sold Separately	15.9
08220202	E-60CFC-D	60"	Forward/Reverse	18"	7234	240	Wet Rated	Yes	Included; 5 speeds	17.2



Accessories

MFG CATALOG NUMBER	MFG MODEL NUMBER	DESCRIPTION
08220302	E-C-CF-D	DC Speed Controller (Max # of fans: 4)

How to Determine the Total # of Ceiling Fans Needed

Ceiling Height (feet)	Coverage Area (square feet)
10 - 11	600
12 - 13	800
14 - 15	950
16 - 17	1100
18 - 19	1300
20 - 21	1450

What to Measure:
Total Square Footage (L x W)
Maximum Ceiling Height

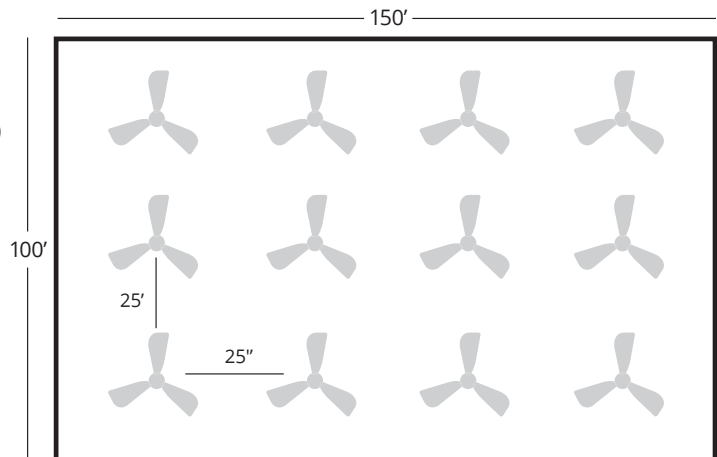

Small Area Example:

If you had a 3,000 square foot facility with 16' ceilings:
Calculation (Total Sq.Ft. / Coverage Area): 3,000/1,100 = 2.73
Total # of fans needed = 3

Large Area Example:

If you had a 10,000 square foot facility with 13' ceilings:
Calculation (Total Sq.Ft. / Coverage Area): 10,000/800 = 12.5
Total # of fans needed = 12 (See chart for layout)

Shutter Mounted Direct Drive Exhaust Fans

Features

- Can be installed from inside wall to eliminate external framing
- Aluminum shutter framing includes weather seals
- Pull chain switch for on/off and speed control
- Aluminum paddle blade assembly, with steel spiral wire guard
- Junction box provided on all models
- **DS Models** - Direct wiring, no cord
- **DSC Models** - Includes 10' long SJT grounded cord
- Made in U.S.A. with domestic and foreign components



CE-DSC
Corded Model



CE-DSC
Direct Wiring Model

Motor Specifications

- 120V, 1-Phase, totally enclosed, permanently lubricated
- 1/20 HP motor is 3-speed sleeve bearing permanent split capacitor
- 1/8 HP motor is 3-speed sleeve bearing permanent split capacitor
- 1/4 HP motor is 2-speed ball bearing permanent split capacitor

Note: Rough-in hole size is 1/2" inch larger than fan blade size
Note: See sizing chart on page 17



WARNING: This product can expose you to chemicals including nickel which is known to the State of California to cause cancer, and chromium, which is known to the State of California to cause birth defects and/or reproductive harm. For more information go to www.P65Warnings.ca.gov.

Standard Models

FAN SIZE	MFG CATALOG NUMBER	MFG MODEL NUMBER	MFG CATALOG NUMBER	MFG MODEL NUMBER	HP	CFM / RPM			AMPS HIGH
						HIGH	MED	LOW	
10"	08689902	CE 10-DS	08218402	CE 10-DSC	1/20	680 / 1560	540 / 1250	460 / 1080	0.8
12"	07986202	CE 12-DS	08218502	CE 12-DSC	1/20	825 / 1560	710 / 1250	560 / 1080	0.8
14"	08690002	CE 14-DS	08218602	CE 14-DSC	1/8	1520 / 1660	1400 / 1550	1250 / 1370	1.7
16"	08690102	CE 16-DS	08218702	CE 16-DSC	1/8	2100 / 1660	1900 / 1550	1700 / 1370	1.7
18"	07986302	CE 18-DS	08218802	CE 18-DSC	1/8	2300 / 1660	2100 / 1050	1850 / 1370	1.7
20"	08690202	CE 20-DS	08218902	CE 20-DSC	1/4	2925 / 1140	-	2380 / 1070	3.2
24"	07986402	CE 24-DS	08219002	CE 24-DSC	1/4	3400 / 1140	-	2770 / 1070	3.2
30"	07986502	CE 30-DS	08219102	CE 30-DSC	1/4	3950 / 1140	-	3080 / 1070	3.2

Dimensions (Inches)

SIZE	DEPTH	DIMENSIONS			WT. (lbs)
		"A"	"B"	"C"	
10"	7.71	13.00	10"	12.375"	11
12"	9.08	15.00	12"	14.375"	16
14"	9.26	17.00	14"	16.75"	17
16"	9.26	19.00	16"	18.250"	18
18"	9.09	21.00	18"	21.750"	25
20"	9.30	23.00	20"	23.686"	34
24"	9.12	27.00	24"	27.750"	47
30"	9.12	33.00	30"	33.750"	54

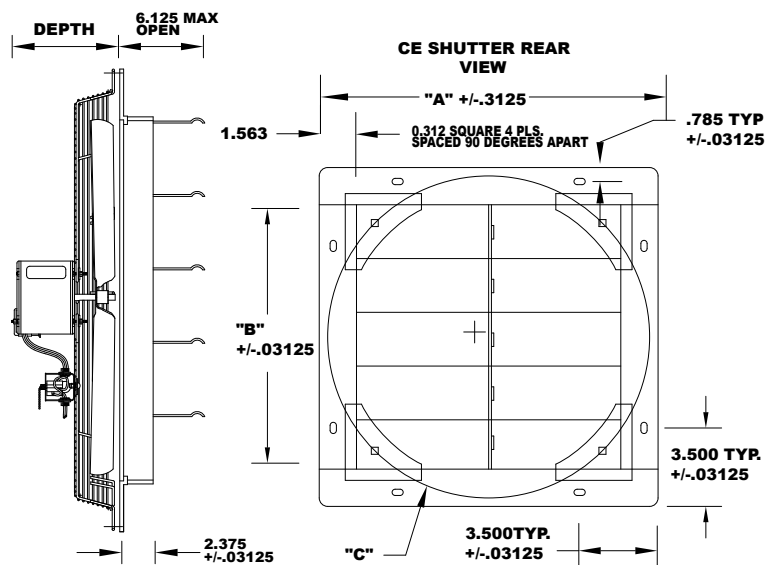

Guard Mounted Direct Drive Exhaust Fans

Features

- Bolts directly to the wall
- Can be used with or without external shutter
- Pull chain switch
- No cord-junction box provided for direct wiring
- Aluminum blade
- Steel spiral wire guards
- Made in U.S.A. with domestic and foreign components.

⚠ WARNING: This product can expose you to chemicals including nickel which is known to the State of California to cause cancer, and chromium, which is known to the State of California to cause birth defects and/or reproductive harm. For more information go to www.P65Warnings.ca.gov.

CE 10-D



* Shutter not included



CE 24-D

Note: Rough-in hole size is 1/2" inch larger than fan blade size
Note See sizing chart on page 17

Motor Specifications

- 120V, 1-Phase, totally enclosed, permanently lubricated
- 1/20 HP motor is 3-speed sleeve bearing permanent split capacitor
- 1/8 HP motor is 3-speed sleeve bearing permanent split capacitor
- 1/4 HP motor is 2-speed ball bearing permanent split capacitor

Standard Models

FAN SIZE	MFG CATALOG NUMBER	MFG MODEL NUMBER	HP	CFM / RPM			AMPS HIGH	WT. (LBS)
				HIGH	MED	LOW		
10"	08689502	CE 10-D	1/20	680 / 1560	540 / 1250	460 / 1080	0.8	11
12"	07985002	CE 12-D	1/20	825 / 1560	710 / 1250	560 / 1080	0.8	12
14"	08689602	CE 14-D	1/8	1520 / 1660	1400 / 1550	1250 / 1370	1.7	17
16"	08689702	CE 16-D	1/8	2100 / 1660	1900 / 1550	1700 / 1370	1.7	18
18"	07984902	CE 18-D	1/8	2300 / 1660	2100 / 1050	1850 / 1370	1.7	19
20"	08689802	CE 20-D	1/4	2925 / 1140	-	2380 / 1070	3.2	34
24"	07984802	CE 24-D	1/4	3400 / 1140	-	2770 / 1070	3.2	38
30"	07984702	CE 30-D	1/4	3950 / 1140	-	3080 / 1070	3.2	42

Dimensions (Inches)

SIZE	BOLT HOLE CENTER WIDTH	DEPTH
10"	14.14"	7.15"
12"	16.46"	8.52"
14"	18.30"	8.70"
16"	20.34"	8.70"
18"	22.64"	8.52"
20"	25.46"	8.70"
24"	29.08"	8.52"
30"	34.89"	8.53"

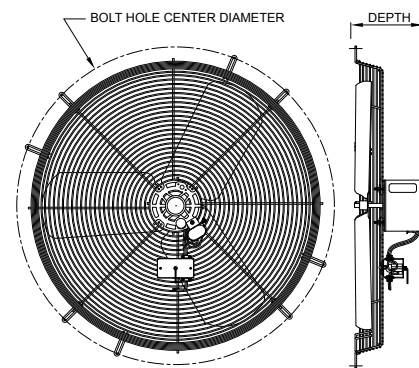

Optional Wall Shutters

FAN SIZE	MFG CATALOG NUMBER	MFG MODEL NUMBER	WT. (LBS)
10"	08684302	CES-10G	5
12"	07985502	CES-12G	5.5
14"	08684502	CES-14G	6.5
16"	08514702	CES-16G	8
18"	07985602	CES-18G	9
20"	07975202	CES-20G	10
24"	07985702	CES-24G	13
30"	07985802	CES-30G	19

Venturi Mounted Direct Drive Exhaust Fans

Features

- Can be installed directly to an existing wall structure
- Designed to be used with or without external shutter
- Steel venturi-shaped mounting frame with powder coated gray finish
- Pull chain switch for on/off and speed control
- Aluminum paddle blade assembly, with steel spiral wire guard
- Junction box provided on all models
- **DV Models** - Direct wiring, no cord
- **DVC Models** - Includes 10' long SJT grounded cord
- Made in U.S.A. with domestic and foreign components



CE-DVC
Corded Model
Rear View



Front View



Motor Specifications

- 120V, 1-Phase, totally enclosed, permanently lubricated
- 1/20 HP motor is 3-speed sleeve bearing permanent split capacitor
- 1/8 HP motor is 3-speed sleeve bearing permanent split capacitor
- 1/4 HP motor is 2-speed ball bearing permanent split capacitor

* Shutter not included

NOTE: Rough-in hole size is 1 1/2 inch larger than fan blade size for models up to 20" ; 2 1/2 for 24-30" models

WARNING: This product can expose you to chemicals including nickel which is known to the State of California to cause cancer, and chromium, which is known to the State of California to cause birth defects and/or reproductive harm. For more information go to www.P65Warnings.ca.gov.

Standard Models

FAN SIZE	MFG CATALOG NUMBER	MFG MODEL NUMBER	MFG CATALOG NUMBER	MFG MODEL NUMBER	HP	CFM / RPM			AMPS HIGH
						HIGH	MED	LOW	
10"	08690302	CE 10-DV	08217602	CE 10-DVC	1/20	680 / 1560	540 / 1250	460 / 1080	0.8
12"	07986602	CE 12-DV	80217702	CE 12-DVC	1/20	825 / 1560	710 / 1250	560 / 1080	0.8
14"	08690402	CE 14-DV	08217802	CE 14-DVC	1/8	1520 / 1660	1400 / 1550	1250 / 1370	1.7
16"	08690502	CE 16-DV	08217902	CE 16-DVC	1/8	2100 / 1660	1900 / 1550	1700 / 1370	1.7
18"	07986702	CE 18-DV	08218002	CE 18-DVC	1/8	2300 / 1660	2100 / 1050	1850 / 1370	1.7
20"	08690602	CE 20-DV	08218102	CE 20-DVC	1/4	2925 / 1140	-	2380 / 1070	3.2
24"	07986802	CE 24-DV	80218202	CE 24-DVC	1/4	3400 / 1140	-	2770 / 1070	3.2
30"	07986902	CE 30-DV	80218302	CE 30-DVC	1/4	3950 / 1140	-	3080 / 1070	3.2

Dimensions (Inches)

SIZE	DEPTH	DIMENSIONS					WT. (lbs)
		"A"	"B" HEIGHT	"C"	"D"	"E"	
10"	7.6	10.250"	12.50"	12.375"	2.000"	12.81"	11
12"	8.96	12.250"	14.50"	14.375"	2.000"	14.625"	17
14"	9.15	14.250"	17.00"	17.375"	2.500"	17.375"	17
16"	9.15	16.250"	19.00"	18.250"	2.875"	20.000"	18
18"	8.97	18.125"	21.00"	21.750"	2.750"	22.875"	26
20"	9.19	20.250"	23.00"	23.686"	2.750"	25.625"	34
24"	9.01	24.250"	29.50" x 28.00"	27.750"	3.63"	--	48
30"	9.01	30.250"	35.50" x 34.00"	33.750"	3.63"	--	55

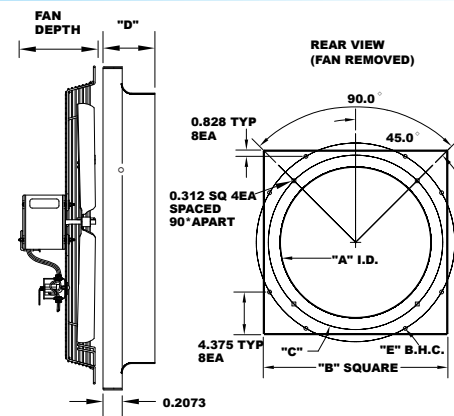

Optional Wall Shutters

FAN SIZE	MFG CATALOG NUMBER	MFG MODEL NUMBER	DIMENSIONS		WT. (lbs)
			WIDTH	LENGTH	
10"	08684302	CES-10G	13.13"	13.13"	5.0
12"	07985502	CES-12G	15.13"	15.13"	5.5
14"	08684502	CES-14G	17.13"	17.13"	6.5
16"	08514702	CES-16G	19.00"	19.00"	8.0
18"	07985602	CES-18G	21.13"	21.13"	9.0
20"	07975202	CES-20G	23.13"	23.13"	10.0
24"	07985702	CES-24G	27.13"	27.13"	13.0
30"	07985802	CES-30G	33.13"	33.13"	19.0

Belt Drive Exhaust Fans & Optional Shutters

Venturi Mounted Belt Drive Exhaust Fan

Features

- Steel venturi frame exhaust fan, bolts directly to an inside wall or framed / vertical surface
- Motor is designed for direct wiring connection; NO cord provided
- Operates at 115/120V at single-phase or 230/460V at 3-phase; 1725 RPMs
- Single speed, belt drive motor constructed of ball bearing, split capacitor, drip proof and is permanently lubricated
- Steel frame has a gray powder coated finish and uses a 4-paddle aluminum blade
- Designed for harsh industrial and commercial environments to improve air quality
- Belt drive motor allows for quieter operation and higher air volume performance
- Can be used with or without external shutter (sold separately)
- UL recognized motor has a frame size of 56
- Proudly designed, engineered, tested and assembled in the USA



Dimensions (Inches)

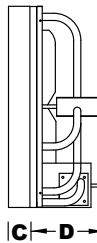
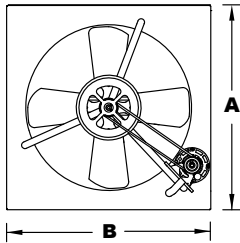

MODEL	DIMENSIONS A x B x C x D
CE-24B	29.5" x 28" x .75" x 17"
CE-30B	35.5" x 34" x .75" x 17"
CE-36B	41.5" x 40" x .75" x 17"
CE-42B	48" x 48" x .75" x 17"
CE-48B	54" x 54" x .75" x 17"

WARNING: This product can expose you to chemicals including nickel which is known to the State of California to cause cancer, and chromium, which is known to the State of California to cause birth defects and/or reproductive harm. For more information go to www.P65Warnings.ca.gov.

Standard Models

SIZE	MOTOR HP	AMPS		CFM	WT. (LBS)	115V 1-PHASE		230/460V 3-PHASE	
		115V	230/460V			MFG CATALOG NUMBER	MFG MODEL NUMBER	MFG CATALOG NUMBER	MFG MODEL NUMBER
24	1/3	5	1.9 / .9	3,000	50	07967002	CE-24B	08510402	CE-24B-3
30	1/3	6	1.9 / .9	4,500	60	07967102	CE-30B	08510502	CE-30B-3
36	1/2	8	2.3 / 1.1	6,900	65	07967202	CE-36B	08510602	CE-36B-3
42	3/4	11	3.3 / 1.5	10,600	75	07967302	CE-42B	08510702	CE-42-B-3
48	1	15	3.8 / 1.9	14,400	98	07967402	CE-48B	08510802	CE-48-B-3

Optional Exhaust Shutters



Features

- Air open - gravity close
- Aluminum frame
- Aluminum louvers
- Weather stripping for tighter seal
- For ONLY CE-Series BELT Drive Fans
- Made in U.S.A.

Standard Models

MFG CATALOG NUMBER	MFG MODEL NUMBER	WT. (lbs)
07967502	CES-24	11
07967602	CES-30	15
07967702	CES-36	19
07967802	CES-42	23
07967902	CES-48	28

Shutter Dimensions (Inches)

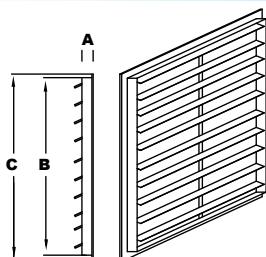

- (A) Thickness
- (B) Blade Housing Size
- (C) Overall Size

MFG MODEL NUMBER	OUTSIDE FRAME DIMENSIONS A x C x C	INSIDE FRAME DIMENSIONS B x B
CES-24	3" x 27" x 27"	24" x 24"
CES-30	3" x 33" x 33"	30" x 30"
CES-36	3" x 39" x 39"	36" x 36"
CES-42	3" x 45" x 45"	42" x 42"
CES-48	3" x 51" x 51"	48" x 48"

* Recommend adding 1/2" to inside frame dimension for wall opening

Industrial Direct Drive Exhaust Fans

Features

- Totally enclosed motors:
 - 1-phase motors are field convertible 115V / 230V
 - 3-phase motors are field convertible 230V / 460V
 - Motors are set to lower voltage at the factory, unless a request is made at time of order to set to the higher voltage
- 14-gauge steel venturi with steel pipe bracing
- 4-blade steel propeller
- 1 year limited warranty



Options

- CES Shutters
- EMF Front Guards
- IBG Rear Guards

WARNING: This product can expose you to chemicals including nickel which is known to the State of California to cause cancer, and chromium, which is known to the State of California to cause birth defects and/or reproductive harm. For more information go to www.P65Warnings.ca.gov.

Standard Models

BLADE SIZE	MFG MODEL NUMBER		PANEL SIZE (Sq.)	HP	RPM	CFM 0" SP	db's @ 10'	WT. (lbs)
	1-PHASE	3-PHASE						
	115/230V-60Hz	208/230/460V-60Hz						
12"	IED12-1/4	IED12-1/4-3	16"	1/4	1725	1480	64	30
16"	IED16-1/3	IED16-1/3-3	20"	1/3	1725	2834	73	40
18"	IED18-1/2	IED18-1/2-3	24"	1/2	1725	3890	74	55
20"	IED20-3/4	IED20-3/4-3	24"	3/4	1725	4574	77	65
24"	IED24-1	IED24-1-3	30"	1	1725	6632	81	155
30"	IED30-1	IED30-1-3	36"	1	1150	8600	79	185
36"	IED36-1 1/2	IED36-1 1/2-3	42"	1.5	1150	12103	82	260
42"	-----	IED42-2-3	48"	2	1150	17315	87	280
48"	-----	IED48-3-3	54"	3	850	24280	86	360

Note: Products listed in this section are custom built and subject to 100% cancellation/restocking charges

Dimensions

SIZE	BLADE DIAMETER	PANEL SIZE	DEPTH DIMENSION
12"	12"	16"	11"
16"	16"	20"	11"
20"	20"	24"	13"
24"	24"	30"	15"
30"	30"	36"	15"
36"	36"	42"	18"
42"	42"	48"	18"
48"	48"	54"	20"

Note: Depth dimension varies with motor selection

Industrial Belt Drive Exhaust Fans

Features

- Totally enclosed motors:
 - 1-phase motors are field convertible 115V / 230V
 - 3-phase motors are field convertible 230V / 460V
 - Motors are set to lower voltage at the factory, unless a request is made at time of order to set to the higher voltage
- 16-gauge steel venturi with steel pipe bracing
- Steel blades
- Double pillow block bearing shaft support
- 1 year limited warranty



Options

- CES Shutters
- EMF Front Guard
- IBG Rear Guards

WARNING: This product can expose you to chemicals including nickel which is known to the State of California to cause cancer, and chromium, which is known to the State of California to cause birth defects and/or reproductive harm. For more information go to www.P65Warnings.ca.gov.

Standard Models

BLADE SIZE	MFG MODEL NUMBER		PANEL SIZE (Sq.)	HP	RPM	CFM	db's @ 10'	WT. (LBS)
	1-PHASE	3-PHASE						
	115/230V-60Hz	208/230/460V-60Hz						
24"	IE24-1/3	IE24-1/3-3	30"	1/3	825	5300	61	70
	IE24-1/2	IE24-1/2-3		1/2	925	6200	66	75
	IE24-3/4	IE24-3/4-3		3/4	1050	7000	71	82
	IE24-1	IE24-1-3		1	1175	7800	73	90
30"	IE30-1/3	IE30-1/3-3	36"	1/3	570	7500	62	95
	IE30-1/2	IE30-1/2-3		1/2	625	8500	64	95
	IE30-3/4	IE30-3/4-3		3/4	725	10000	66	105
	IE30-1	IE30-1-3		1	825	11000	70	115
36"	IE36-1/3	IE36-1/3-3	42"	1/3	425	9000	64	103
	IE36-1/2	IE36-1/2-3		1/2	500	10500	66	105
	IE36-3/4	IE36-3/4-3		3/4	575	11900	68	110
	IE36-1	IE36-1-3		1	650	13100	70	120
	IE36-1 1/2	IE36-1 1/2-3		1 1/2	750	15000	72	155
	IE36-2	IE36-2-3		2	830	16500	74	165
42"	IE42-3/4	IE42-3/4-3	48"	3/4	430	14000	67	175
	IE42-1	IE42-1-3		1	490	15400	69	180
	IE42-1 1/2	IE42-1 1/2-3		1 1/2	550	17200	71	185
	IE42-2	IE42-2-3		2	620	19400	74	200
	-----	IE42-3-3		3	700	22000	79	225
48"	IE48-3/4	IE48-3/4-3	54"	3/4	350	17000	70	185
	IE48-1	IE48-1-3		1	400	19100	71	190
	IE48-1 1/2	IE48-1 1/2-3		1 1/2	460	22000	72	200
	IE48-2	IE48-2-3		2	520	24000	74	250
	-----	IE48-3-3		3	590	27500	80	260
	-----	IE48-5-3		5	660	30500	83	280
60"	IE60-2	IE60-2-3	66"	2	320	31000	77	320
	-----	IE60-3-3		3	370	35000	84	330
	-----	IE60-5-3		5	420	39000	86	350

Note: Products listed in this section are custom built and subject to 100% cancellation/restocking charges

Dimensions

SIZE	BLADE DIAMETER	PANEL SIZE	DEPTH DIMENSION
24"	24"	30"	18"
30"	30"	36"	18"
36"	36"	42"	20"
42"	42"	48"	20"
48"	48"	54"	22"
60"	60"	66"	28"

Note: Depth dimension varies with motor selection

Heavy Duty Direct Drive Exhaust Fans

Features

- Totally enclosed and explosion proof motors
 - Explosion proof motors are Class 1, Div 1
 - Group D and Class 2, Div 1, Groups F & G
- Fans are shipped completely assembled
- Cast aluminum blades
- 14 gauge steel panel with welded steel pipe bracing
- 1 year limited warranty

⚠ WARNING: This product can expose you to chemicals including nickel which is known to the State of California to cause cancer, and chromium, which is known to the State of California to cause birth defects and/or reproductive harm. For more information go to www.P65Warnings.ca.gov.



Options

- CES shutters
- Acid resistant coating
- EMF front guards
- Reversed airflow
- IBG rear guards
- Flat front venturi

Standard Models

BLADE SIZE	MFG MODEL NUMBER		PANEL SIZE (Sq.)	HP	RPM	CFM 0" SP	db's @ 10'	WT. (LBS)
	1-PHASE	3-PHASE						
	115/230V-60Hz	208/230/460V-60Hz						
12"	EHD12-1/4	EHD12-1/4-3	16"	1/4	1725	1180	74	35
16"	EHD16-1/4	EHD16-1/4-3	20"	1/4	1725	2800	75	45
18"	EHD18-1/3	EHD18-1/3-3	24"	1/3	1725	3375	75	60
	EHD18-1/2	EHD18-1/2-3		1/2	1725	4150	76	60
20"	EHD20-1/4	EHD20-1/4-3		1/4	1725	3720	75	60
	EHD20-1/2	EHD20-1/2-3		1/2	1725	4800	76	65
	EHD20-1	EHD20-1-3	1	1725	6900	77	70	
24"	EHD24-1/4	EHD24-1/4-3	30"	1/4	1725	5200	82	135
	EHD24-1/3	EHD24-1/3-3		1/3	1150	4975	75	145
	EHD24-1/2	EHD24-1/2-3		1/2	1725	6510	82	140
	EHD24-3/4	EHD24-3/4-3		3/4	1725	6900	83	145
	EHD24-1	EHD24-1-3		1	1725	7425	83	155
	EHD24-2	EHD24-2-3		2	1725	9525	83	165
30"	-----	EHD24-3-3	36"	3	1725	10500	85	170
	EHD30-1/3	EHD30-1/3-3		1/3	1150	6950	79	145
	EHD30-1/2	EHD30-1/2-3		1/2	1725	8980	89	135
	EHD30-3/4	EHD30-3/4-3		3/4	1150	10440	79	175
	-----	EHD30-1-3		1	870	10640	74	215
	EHD30-1 1/2	EHD30-1 1/2-3		1 1/2	1725	12000	89	165
36"	EHD30-2	EHD30-2-3	42"	2	1150	14000	82	215
	-----	EHD30-3-3		3	1725	16000	89	190
	EHD36-1	EHD36-1-3		1	1150	13600	84	225
	-----	EHD36-2-3		2	1150	17620	84	250
	-----	EHD36-3-3		3	1150	20500	85	255
42"	-----	EHD36-5-3	48"	5	1725	28000	94	250
	-----	EHD42-1-3		1	870	15800	82	300
	EHD42-2	EHD42-2-3		2	1150	17964	88	260
	-----	EHD42-3-3		3	1150	24500	88	270
48"	-----	EHD42-5-3	54"	5	1150	28970	88	285
	-----	EHD48-3-3		3	1150	28600	92	290
	-----	EHD48-5-3		5	1150	32000	94	305
60"	-----	EHD60-3-3	66"	3	1150	40000	97	700
	-----	EHD60-5-3		5	1150	45000	97	730
	-----	EHD60-7 1/2-3		7 1/2	870	47000	92	740
	-----	EHD60-10-3		10	870	57200	93	750

Single phase motors are field convertible 115V/230V.
Three phase motors are field convertible 230V/460V.

Motors are set to lower voltage at the factory, unless a request is made at time of order to set to the higher voltage.

Note: Products listed in this section are custom built and subject to 100% cancellation/restocking charges

*Not all EXP motors are 208V capable

Dimensions

SIZE	BLADE DIAMETER	PANEL SIZE	DEPTH DIMENSION
12"	12"	16"	11"
16"	16"	20"	11"
20"	20"	24"	13"
24"	24"	30"	15"
30"	30"	36"	15"
36"	36"	42"	18"
42"	42"	48"	18"
48"	48"	54"	20"
60"	60"	66"	22"

Note: Depth dimension varies with motor selection

Heavy Duty Belt Drive Exhaust Fans

Features

- Totally enclosed and explosion proof motors
 - Explosion proof motors are Class 1, Div 1
 - Group D and Class 2, Div 1, Groups F & G
- Fans are shipped completely assembled
- Heavy gauge steel blades on TEC models
- Cast aluminum blades on EXP explosion proof models
- 14 gauge steel panel with welded steel pipe bracing year limited warranty
- For optimum shutter efficiency, mount shutter 1/3 the distance of the fan opening size.
- Example: 36" fan shutter would be mounted 12" from the fan blade

Options

- CES shutters
- EMF front guards
- IBG rear guards
- Reversed airflow
- Flat front venturi



Standard Models

BLADE SIZE	MFG MODEL NUMBER		PANEL SIZE (Sq.)	HP	RPM	CFM 0" SP	db's @ 10"	WT. (lbs)
	1-PHASE	3-PHASE						
	115/230V-60Hz	208/230/460V-60Hz						
24"	EHB24-1/4	EHB24-1/4-3	30"	1/4	780	4900	60	100
	EHB24-1/2	EHB24-1/2-3		1/2	980	6219	66	130
	EHB24-3/4	EHB24-3/4-3		3/4	1140	7090	71	140
	EHB24-1	EHB24-1-3		1	1250	7180	73	140
30"	EHB30-1/4	EHB30-1/4-3	36"	1/4	540	7178	61	140
	EHB30-1/3	EHB30-1/3-3		1/3	595	7909	63	150
	EHB30-1/2	EHB30-1/2-3		1/2	640	8507	64	155
	EHB30-3/4	EHB30-3/4-3		3/4	770	10235	66	165
	EHB30-1	EHB30-1-3		1	975	10668	70	170
	EHB30-1 1/2	EHB30-1 1/2-3		1 1/2	1140	12473	77	180
36"	EHB36-1/3	EHB36-1/3-3	42"	1/3	460	9113	64	160
	EHB36-1/2	EHB36-1/2-3		1/2	530	10500	66	180
	EHB36-3/4	EHB36-3/4-3		3/4	605	11985	68	200
	EHB36-1	EHB36-1-3		1	665	13174	70	200
	EHB36-1 1/2	EHB36-1 1/2-3		1 1/2	720	13660	72	210
	EHB36-2	EHB36-2-3		2	870	16554	74	215
42"	EHB42-1/3	EHB42-1/3-3	48"	1/3	335	10614	64	205
	EHB42-1/2	EHB42-1/2-3		1/2	390	12343	65	210
	EHB42-3/4	EHB42-3/4-3		3/4	435	14040	67	225
	EHB42-1	EHB42-1-3		1	490	15429	69	230
	EHB42-1 1/2	EHB42-1 1/2-3		1 1/2	550	17420	71	240
	EHB42-2	EHB42-2-3		2	725	20653	74	245
	----	EHB42-3-3		3	830	23645	79	250
48"	EHB48-1/2	EHB48-1/2-3	54"	1/2	330	15230	69	190
	EHB48-3/4	EHB48-3/4-3		3/4	370	17339	70	195
	EHB48-1	EHB48-1-3		1	410	19188	71	235
	EHB48-1 1/2	EHB48-1 1/2-3		1 1/2	465	21731	72	245
	EHB48-2	EHB48-2-3		2	520	24274	74	250
	----	EHB48-3-3		3	680	28150	80	270
	----	EHB48-5-3		5	800	33160	83	285
60"	EHB60-1	EHB60-1-3	66"	1	280	23090	76	380
	EHB60-1 1/2	EHB60-1 1/2-3		1 1/2	340	28068	77	390
	EHB60-2	EHB60-2-3		2	390	32200	78	395
	----	EHB60-3-3		3	450	37183	84	410
	----	EHB60-5-3		5	540	44600	86	420

Dimensions

SIZE	BLADE DIAMETER	PANEL SIZE	DEPTH DIMENSION
24"	24"	30"	16"
30"	30"	36"	16"
36"	36"	42"	18"
42"	42"	48"	20"
48"	48"	54"	21"
60"	60"	66"	26"

WARNING: This product can expose you to chemicals including nickel which is known to the State of California to cause cancer, and chromium, which is known to the State of California to cause birth defects and/or reproductive harm. For more information go to www.P65Warnings.ca.gov.

Note: Depth dimension varies with motor selection.

Cabinet Exhaust Fans With Shutters

Features

- 120V, 1-Phase or 230 / 460V, 3-phase, ball bearing, permanently lubricated, drip proof motor - UL listed
- Permanently lubricated bearings on blade drive shaft
- Aluminum blade
- Aluminum shutter
- 20-gauge powder coated venturi
- 18-gauge galvanized steel housing
- 1725 RPM motor
- Motor frame size 56 / Shaft: 5/8"
- Ships fully assembled
- Meets OSHA Standards
- 1 year warranty
- Made in U.S.A.

⚠ WARNING: This product can expose you to chemicals including nickel which is known to the State of California to cause cancer, and chromium, which is known to the State of California to cause birth defects and/or reproductive harm. For more information go to www.P65Warnings.ca.gov.



Standard Models

SIZE	MOTOR HP	AMPS		CFM	WT. (LBS)	115V 1-PHASE		230 / 460V 3-PHASE	
		115V	230/460V			MFG CATALOG NUMBER	MFG MODEL NUMBER	MFG CATALOG NUMBER	MFG MODEL NUMBER
30	1/3	6	1.9 / .9	4,500	120	08684002	CBT-30B	08685302	CBT-30B-3
36	1/2	8	2.3 / 1.1	6,900	135	08684102	CBT-36B	08685402	CBT-36B-3
42	3/4	11	3.3 / 1.5	10,600	155	08684202	CBT-42B	08685502	CBT-42B-3
48	1	15	3.8 / 1.9	14,400	200	08685102	CBT-48B	08685002	CBT-48B-3

Dimensions

SIZE	OUTSIDE DIMENSIONS			MAXIMUM REQUIRED INSIDE WALL OPENING
	HEIGHT	WIDTH	DEPTH	
24"	28 1/4"	28 1/4"	22 1/2"	28 3/4" x 28 3/4"
30"	34 1/4"	34 1/4"	22 1/2"	34 1/2" x 34 1/2"
36"	40 1/4"	40 1/4"	18 1/2"	40 1/2" x 40 1/2"
42"	48 1/2"	48 1/2"	18 1/2"	48 3/4" x 48 3/4"
48"	54 1/2"	54 1/2"	21 1/2"	54 3/4" x 54 3/4"

Exhaust Fan Accessories - Heavy Duty Exhaust Shutter

Features

- Air open - gravity close
- Aluminum construction
- Heavy duty blades
- Weather stripping for tighter seal
- For optimum shutter efficiency, mount shutter $\frac{1}{3}$ the distance of the fan opening size (Example: 36" fan shutter would be mounted 12" from the fan blade)
- Shutter should be sized to fit exhaust opening
- For IE, IED, EHB and EHD models



WARNING: This product can expose you to chemicals including nickel which is known to the State of California to cause cancer, and chromium, which is known to the State of California to cause birth defects and/or reproductive harm. For more information go to www.P65Warnings.ca.gov.

Standard Models

FAN SIZE	MFG CATALOG NUMBER	MFG MODEL NUMBER	INSIDE FRAME DIMENSIONS	OUTSIDE FRAME DIMENSIONS	WT. (lbs)
12"	07983302	CES 12-HD	12" x 12"	14" x 15"	4
16"	08709102	CES 16-HD	16" x 16"	19" x 19"	7
18"	08518902	CES 18-HD	18" x 18"	21" x 21"	8
20"	08696602	CES 20-HD	20" x 20"	23" x 23"	9
24"	08757202	CES 24-HD	24" x 24"	27" x 27"	11
30"	08757302	CES 30-HD	30" x 30"	33" x 33"	15
36"	08757402	CES 36-HD	36" x 36"	39" x 39"	19
42"	08757502	CES 42-HD	42" x 42"	45" x 45"	23
48"	08757602	CES 48-HD	48" x 48"	51" x 51"	28
54"	08775102	CES 54-HD	54" x 54"	57" x 57"	39
60"	07998702	CES 60-HD	60" x 60"	63" x 63"	47

Heavy Duty Shutter Motor Kit Features



- Used to open shutter when shutter is used to provide make-up air (shutter should be one size larger than exhaust fan size and should be located on opposite wall)
- Used for positive closure of exhaust shutter
- 115V or 230V, 60 HZ, 1-Phase

Standard Models

MFG CATALOG NUMBER	MFG MODEL NUMBER	DESCRIPTION	WT. (lbs)
07971002	MK-1	For shutter sizes 12" thru 30" (Single Panel)	5
07971102	MK-2	For shutter sizes 36" thru 60" (Double Panel)	8

Motorized Supply Air Intake Shutter

Features

- Inward opening blades for use with intake fans when shutter is located directly in air stream
- Galvanized construction
- 115V or 230V, 60 HZ, 1-Phase
- For IE, IED, EHB and EHD models

WARNING: This product can expose you to chemicals including nickel which is known to the State of California to cause cancer, and chromium, which is known to the State of California to cause birth defects and/or reproductive harm. For more information go to www.P65Warnings.ca.gov.

Standard Models

FAN SIZE	MFG CATALOG NUMBER	MFG MODEL NUMBER	ROUGH OPENING	OVERALL SIZE	WT. (lbs)
24"	08516902	CESM-24	24" x 24"	27" x 27"	15
30"	08007102	CESM-30	30" x 30"	33" x 33"	18
36"	08004602	CESM-36	36" x 36"	39" x 39"	21
42"	08517202	CESM-42	42" x 42"	45" x 45"	35
48"	07997202	CESM-48	48" x 48"	51" x 51"	42
60"	07983002	CESM-60	60" x 60"	63" x 63"	56



Exhaust Fan Accessories - Fan Guards

Rear Box Guard Bolt Together With Wire Guards



WARNING: This product can expose you to chemicals including nickel which is known to the State of California to cause cancer, and chromium, which is known to the State of California to cause birth defects and/or reproductive harm. For more information go to www.P65Warnings.ca.gov.

Features

- For IE, IED, EHB and EHD models
- 1/4" smaller than the panel size of the fan
- Meets OSHA requirements

Standard Models

MFG MODEL NUMBER	FITS FAN SIZE
IBG-24	24"
IBG-30	30"
IBG-36	36"
IBG-42	42"
IBG-48	48"
IBG-60	60"

Rear Expanded Metal Box Guard



WARNING: This product can expose you to chemicals including nickel which is known to the State of California to cause cancer, and chromium, which is known to the State of California to cause birth defects and/or reproductive harm. For more information go to www.P65Warnings.ca.gov.

Features

- For IE, IED, EHB and EHD models
- 1/4" smaller than the panel size of the fan
- Meets OSHA requirements

Standard Models

MFG MODEL NUMBER	FITS FAN SIZE
IBG-12	12"
IBG-16	16"
IBG-18	18"
IBG-20	20"

Spiral Front and Rear Guards

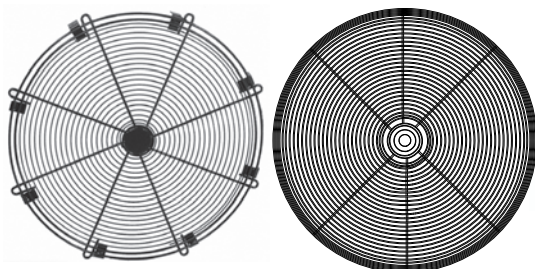

Spiral Front

Spiral Rear

WARNING: This product can expose you to chemicals including nickel which is known to the State of California to cause cancer, and chromium, which is known to the State of California to cause birth defects and/or reproductive harm. For more information go to www.P65Warnings.ca.gov.

Features

- For EHD models only
- Fits between motor and blade
- Rear guard installed at factory only
- Meets OSHA requirements

Standard Models

MFG MODEL NUMBER	TYPE	FITS FAN SIZE
SF-12	SPIRAL FRONT	12"
SF-16		16"
SF-18		18"
SF-20		20"
SF-24		24"
SR-12	SPIRAL REAR	12"
SR-16		16"
SR-18		18"
SR-20		20"
SR-24		24"

Expanded Metal Front Guard



Expanded metal guard 60"

WARNING: This product can expose you to chemicals including nickel which is known to the State of California to cause cancer, and chromium, which is known to the State of California to cause birth defects and/or reproductive harm. For more information go to www.P65Warnings.ca.gov.

Features

- For EHB, EHD, IE, & IED models
- 1" larger than blade size
- Meets OSHA requirements

Standard Models

MFG MODEL NUMBER	FITS FAN SIZE
EMF-12	12"
EMF-16	16"
EMF-20	20"
EMF-24	24"
EMF-30	30"
EMF-36	36"
EMF-42	42"
EMF-48	48"
EMF-60	60"

Cabinet Exhaust Fan Package Option

With Bolt Together Rear Guard

Package Includes

- Wall collar
- Automatic shutter
- Rear box guard

* Exhaust fan sold separately

Features

- For IE, IED, EHB and EHD models
- Wall collar OD is 1/4" larger than fan panel size
- Meets OSHA requirements

Standard Models

MFG MODEL NUMBER	FAN SIZE
CEFP-24	24"
CEFP-30	30"
CEFP-36	36"
CEFP-42	42"
CEFP-48	48"

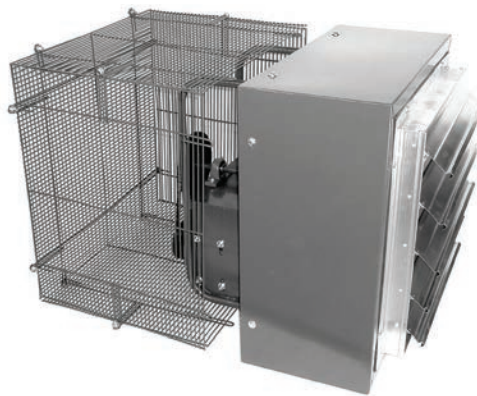

WARNING: This product can expose you to chemicals including nickel which is known to the State of California to cause cancer, and chromium, which is known to the State of California to cause birth defects and/or reproductive harm. For more information go to www.P65Warnings.ca.gov.

With Expanded Metal Rear Guard

Package Includes

- Wall collar
- Automatic shutter
- Rear box guard

* Exhaust fan sold separately

Features

- For IE, IED, EHB and EHD models
- Wall collar OD is 1/4" larger than fan panel size
- Meets OSHA requirements

Standard Models

MFG MODEL NUMBER	FAN SIZE
CEFP-12	12"
CEFP-16	16"
CEFP-18	18"
CEFP-20	20"
CEFP-60	60"

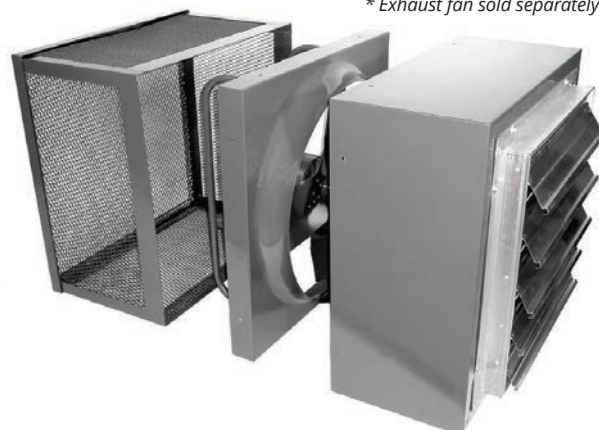

WARNING: This product can expose you to chemicals including nickel which is known to the State of California to cause cancer, and chromium, which is known to the State of California to cause birth defects and/or reproductive harm. For more information go to www.P65Warnings.ca.gov.

Exterior Weather Hood Option

Features

- For IE, IED, EHB and EHD models
- Galvanized housing with 1/2 - 16 expanded metal bird screen
- Can be used for intake or exhaust
- Meets OSHA requirements

Standard Models

MFG MODEL NUMBER	FAN SIZE
WH-12	12"
WH-16	16"
WH-18	18"
WH-20	20"
WH-24	24"
WH-30	30"
WH-36	36"
WH-42	42"
WH-48	48"
WH-60	60"



WARNING: This product can expose you to chemicals including nickel which is known to the State of California to cause cancer, and chromium, which is known to the State of California to cause birth defects and/or reproductive harm. For more information go to www.P65Warnings.ca.gov.

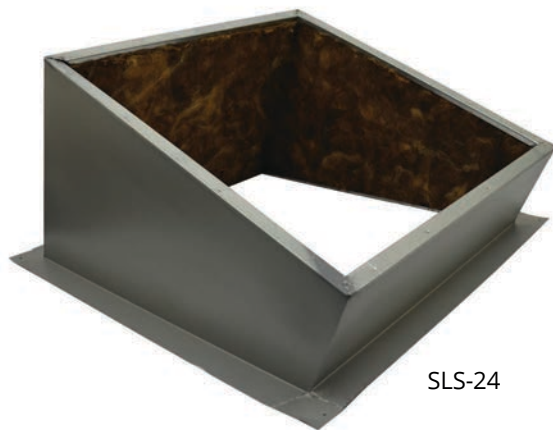

SLS-24

Features

- Used with UEB, UED, and RE roof ventilators
- For flat, single slope or ridge style roofs
- Galvanized steel construction
- 1 ½" insulated thickness, 3 pounds density
- 8" height overall
- Not for corrugated roofs

⚠ WARNING: This product can expose you to chemicals including nickel which is known to the State of California to cause cancer, and chromium, which is known to the State of California to cause birth defects and/or reproductive harm. For more information go to www.P65Warnings.ca.gov.

Standard Models

FAN	MFG MODEL NUMBER			BASE DIMENSION	OVERALL DIMENSION
	FLAT	SLOPE	RIDGE		
18"	FLS-18	SLS-18	RDS-18	32" x 32"	44" x 44"
24"	FLS-24	SLS-24	RDS-24	38" x 38"	50" x 50"
30"	FLS-30	SLS-30	RDS-30	44" x 44"	56" x 56"
36"	FLS-36	SLS-36	RDS-36	50" x 50"	62" x 62"
42"	FLS-42	SLS-42	RDS-42	56" x 56"	68" x 68"
48"	FLS-48	SLS-48	RDS-48	62" x 62"	74" x 74"
54"	FLS-54	SLS-54	RDS-54	68" x 68"	80" x 80"
60"	FLS-60	SLS-60	RDS-60	74" x 74"	86" x 86"

Back Draft Dampers to Fit in Curb

UEB and UED models require higher curb height when used with back draft damper; consult factory

FAN SIZE	MFG MODEL NUMBER	SHUTTER SIZE
18"	CD-18	28" x 28"
24"	CD-24	34" x 34"
30"	CD-30	40" x 40"
36"	CD-36	46" x 46"
42"	CD-42	52" x 52"
48"	CD-48	58" x 58"
54"	CD-54	64" x 64"
60"	CD-60	70" x 70"

Motor Kit for Dampers

115V or 230V, 60Hz, 1-Phase. (Specify Voltage)

MFG MODEL NUMBER	DESCRIPTION	WT. (LBS)
DMKP1	For shutter sizes 18" thru 36"	5
DMKP2	For shutter sizes 42" thru 60"	8

Belt Drive Hooded Roof Ventilators

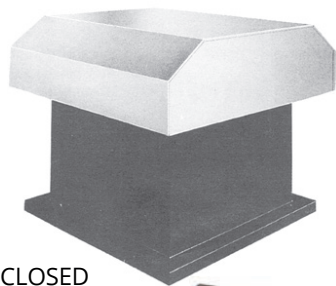

CLOSED

WARNING: This product can expose you to chemicals including nickel which is known to the State of California to cause cancer, and chromium, which is known to the State of California to cause birth defects and/or reproductive harm. For more information go to www.P65Warnings.ca.gov.



OPEN

Features

- Used for exhaust or intake
- Heavy industrial steel base with aluminum hood
- Steel blades
- Bird screen included
- No back draft protection in standard construction dampers offered as optional accessory
- 1 year limited warranty

Options

- Direct drive
- Protective coatings
- Roof curb
- Filters

Dimensions

SIZE	MINIMUM ROOF HOLE (SQUARE)	HOLE LENGTH x WIDTH	HOOD HEIGHT	ROOF CURB O.D. (SQUARE)
24"	30"	54" x 64"	30"	39"
30"	36"	60" x 76"	36"	45"
36"	42"	72" x 82"	40"	51"
42"	48"	80" x 89"	43"	57"
48"	54"	87" x 95"	46"	63"
54"	60"	92" x 98"	54"	69"
60"	66"	90" x 107"	56"	75"

Standard Models

BLADE SIZE	1-PHASE 115/230V	3-PHASE 208/230/460V	HP	RPM	C.F.M - STATIC PRESSURE				Db's @ 10'	WT. (LBS)
	MFG MODEL NUMBER				0"	1/8"	1/4"	1/2"		
24"	RE24-1/4	RE24-1/4-3	1/4	780	4900	4222	2807	800	60	340
	RE24-1/2	RE24-1/2-3	1/2	980	6219	5716	5061	2600	66	350
	RE24-3/4	RE24-3/4-3	3/4	1140	7090	6648	6144	4413	71	360
	RE24-1	RE24-1-3	1	1250	7180	6696	6271	4464	73	365
30"	RE30-1/3	RE30-1/3-3	1/3	595	7909	6380	3617	767	60	385
	RE30-1/2	RE30-1/2-3	1/2	640	8507	7170	4486	1373	64	385
	RE30-3/4	RE30-3/4-3	3/4	770	10235	9192	7657	3833	66	400
	RE30-1	RE30-1-3	1	975	10668	9959	8626	5184	70	400
	RE30-1 1/2	RE30-1 1/2-3	1.5	1140	12473	11867	11112	8135	77	410
36"	RE36-1/3	RE36-1/3-3	1/3	460	9113	6992	3722	486	64	425
	RE36-1/2	RE36-1/2-3	1/2	530	10500	8821	5985	2084	66	425
	RE36-3/4	RE36-3/4-3	3/4	605	11985	10583	8563	4017	68	435
	RE36-1	RE36-1-3	1	665	13174	11932	10299	5729	70	440
	RE36-1 1/2	RE36-1 1/2-3	1.5	720	13660	12012	9579	5000	72	440
	RE36-2	RE36-2-3	2	870	16554	15376	14088	9691	74	455
42"	RE42-1/2	RE42-1/2-3	1/2	390	12343	9352	4957	1642	65	540
	RE42-3/4	RE42-3/4-3	3/4	435	14040	11530	7633	3311	67	545
	RE42-1	RE42-1-3	1	490	15429	13194	10438	4668	69	555
	RE42-1 1/2	RE42-1 1/2-3	1.5	550	17420	15421	13117	7289	71	560
	RE42-2	RE42-2-3	2	725	20653	19128	17503	11319	74	570
	-----	RE42-3-3	3	830	23645	22296	20984	17290	79	585
48"	RE48-3/4	RE48-3/4-3	3/4	370	17339	13700	7389	2244	70	650
	RE48-1	RE48-1-3	1	410	19188	16078	10903	4037	71	660
	RE48-1 1/2	RE48-1 1/2-3	1.5	465	21731	19010	14991	7081	72	665
	RE48-2	RE48-2-3	2	520	24274	21943	19080	10125	74	680
	-----	RE48-3-3	3	680	28150	25683	23615	16930	80	700
	-----	RE48-5-3	5	800	33160	30900	29290	25000	83	720
54"	RE54-1	RE54-1-3	1	410	23130	20588	17500	9600	73	910
	RE54-1 1/2	RE54-1 1/2-3	1.5	450	25400	22600	19300	10316	75	920
	RE54-2	RE54-2-3	2	480	27200	24312	20660	11010	76	930
	-----	RE54-3-3	3	550	31213	28722	25830	15420	77	940
	-----	RE54-5-3	5	660	37458	35238	32893	26538	80	960
60"	RE60-1	RE60-1-3	1	250	23090	19161	12850	----	76	1150
	RE60-1 1/2	RE60-1 1/2-3	1.5	340	28068	23283	15624	8000	77	1150
	RE60-2	RE60-2-3	2	390	32200	26710	17924	9380	78	1200
	-----	RE60-3-3	3	450	37183	32356	25324	15013	84	1220
	-----	RE60-5-3	5	540	44600	41232	35819	23237	86	1240
	-----	RE60-7 1/2-3	7.5	620	50184	47603	43981	32880	89	1285

Note: Products listed in this section are custom built and subject to 100% cancellation/restocking charges

Direct Drive Roof Ventilators



Features

- Cast Aluminum blades on most models
- Totally enclosed and explosion proof motors
- 1-Phase motors are field convertible 115V/230V
- 3-Phase motors are field convertible 230V/460V
- Motors are set to lower voltage at the factory unless a request is made at time of order to set them to the higher voltage
- Explosion proof motors are Class 1, Div 1, Group D and Class 2, Div 1, Groups F & G
- Wind band is 18 gauge galvanized steel
- Rubber shim under dampers for better seal
- Size of roof opening to be 6" larger than fan size
- Some models available with low R.P.M. motor for quieter operation
- 1 year limited warranty

⚠ WARNING: This product can expose you to chemicals including nickel which is known to the State of California to cause cancer, and chromium, which is known to the State of California to cause birth defects and/or reproductive harm. For more information go to www.P65Warnings.ca.gov.

Options

- Protective coating
- Prefabricated curbs
- Disconnect switch

Standard Models

BLADE SIZE	1-PHASE 115/230V	3-PHASE 208/230/460V	HP	RPM	C.F.M - STATIC PRESSURE				Db's @ 10'	WT. (LBS)
	MFG MODEL NUMBER				0"	1/8"	1/4"	1/2"		
18"	UED18-1/4	UED18-1/4-3	1/4	1140	2570	2263	1673	854	66	170
	UED18-1/3	UED18-1/3-3	1/3	1725	3375	3000	2600	1400	75	175
	UED18-1/2	UED18-1/2-3	1/2	1725	4133	3938	3724	3132	76	180
	UED18-1	UED18-1-3	1	1725	4600	4375	4080	3000	77	190
24"	UED24-1/4	UED24-1/4-3	1/4	1725	5200	4200	2820	----	75	240
	UED24-3/4	UED24-3/4-3	3/4	1140	6900	6450	6265	3300	76	260
	UED24-1	UED24-1-3	1	1725	7425	7000	6350	5000	83	280
	-----	UED24-3-3	3	1725	10500	9800	9500	8700	85	295
30"	UED30-3/4	UED30-3/4-3	3/4	1140	10440	9750	8750	6000	79	310
	-----	UED30-1-3	1	870	10800	10100	9100	6360	74	330
	UED30-1 1/2	UED30-1 1/2-3	1.5	1140	10410	9686	8834	6420	81	325
	UED30-2	UED30-2-3	2	1140	14000	13750	12900	10450	82	335
	-----	UED30-3-3	3	1725	16000	15350	14700	12900	89	335
36"	UED36-2	UED36-2-3	2	1140	17620	16500	15200	12300	84	430
	-----	UED36-3-3	3	1140	20500	19500	18500	15850	85	455
	-----	UED36-5-3	5	1140	22600	21700	20500	19000	87	465
42"	UED42-2	UED42-2-3	2	1140	17964	17277	15326	12351	88	500
	-----	UED42-5-3	5	1140	28970	27960	26840	24200	89	500
48"	-----	UED48-3-3	3	1140	28600	26500	24400	20000	92	550
	-----	UED48-5-3	5	870	33000	31500	29750	25300	86	665
	-----	UED48-7 1/2-3	7.5	1140	37000	35100	32800	28000	94	740
	-----	UED48-10-3	10	1140	41000	39200	38300	35400	95	875
60"	-----	UED60-5-3	5	870	45200	41500	37000	26000	90	940
	-----	UED60-7 1/2-3	7.5	870	47000	45500	43600	38700	92	950

*Not all EXP motors are 208V capable

Note: Products listed in this section are custom built and subject to 100% cancellation/restocking charges

Dimensions

SIZE	MINIMUM ROOF HOLE SIZE (SQUARE)	WIND BAND OUTER DIMENSION	ROOF CURB OUTER DIMENSION (SQUARE)	WIND BAND HEIGHT
18"	28"	24"	33"	16"
24"	34"	30"	39"	19"
30"	40"	36"	45"	22"
36"	46"	42"	51"	25"
42"	52"	48"	57"	27"
48"	58"	54"	63"	30"
60"	70"	66"	75"	42"

Belt Drive Roof Ventilators

Features

- Standard blades are heavy gauge steel
- Totally enclosed motors
- 1-Phase motors are field convertible 115V/230V
- 3-Phase motors are field convertible 230V/460V
- Motors are set to lower voltage at factory unless a request is made at time of order to set them to the higher voltage
- Wind band is 18 gauge galvanized steel
- Galvanized steel butterfly damper with rubber stops and seals
- Size of the roof opening to be 6" larger than fan size (Wind Band O.D.) dimension
- 1 year limited warranty



WARNING: This product can expose you to chemicals including nickel which is known to the State of California to cause cancer, and chromium, which is known to the State of California to cause birth defects and/or reproductive harm. For more information go to www.P65Warnings.ca.gov.

Options

- Protective coating
- Prefabricated curbs
- Disconnect switch

Standard Models

BLADE SIZE	1-PHASE 115/230V	3-PHASE 208/230/460V	HP	RPM	C.F.M - STATIC PRESSURE				Db's @ 10'	WT. (LBS)
	MFG MODEL NUMBER				0"	1/8"	1/4"	1/2"		
24"	UEB24-1/3	UEB24-1/3-3	1/3	780	4900	4222	2807	800	64	300
	UEB24-1/2	UEB24-1/2-3	1/2	980	6219	5716	5661	2600	66	305
	UEB24-3/4	UEB24-3/4-3	3/4	1140	7090	6648	6144	4413	71	310
30"	UEB30-1/2	UEB30-1/2-3	1/2	640	8507	7170	4486	1373	64	350
	UEB30-3/4	UEB30-3/4-3	3/4	770	10235	9192	7657	3833	66	360
	UEB30-1	UEB30-1-3	1	975	10668	9959	8626	5184	70	370
36"	UEB36-1/2	UEB36-1/2-3	1/2	530	10500	8821	5985	2084	66	360
	UEB36-3/4	UEB36-3/4-3	3/4	605	11985	10583	8563	4017	68	370
	UEB36-1	UEB36-1-3	1	665	13174	11932	10299	5729	70	390
	UEB36-1 1/2	UEB36-1 1/2-3	1.5	720	13660	12012	9579	5000	72	395
42"	UEB42-3/4	UEB42-3/4-3	3/4	435	14040	11530	7633	3311	67	455
	UEB42-1	UEB42-1-3	1	490	15429	13194	10438	4668	69	465
	UEB42-1 1/2	UEB42-1 1/2-3	1.5	550	17420	15421	13117	7289	71	470
	UEB42-2	UEB42-2-3	2	725	20653	19128	17503	11319	74	485
	-----	UEB42-3-3	3	830	23645	22296	20984	17290	79	495
48"	UEB48-3/4	UEB48-3/4-3	3/4	370	17339	13700	7389	2244	70	505
	UEB48-1	UEB48-1-3	1	410	19188	16078	10903	4037	71	520
	UEB48-1 1/2	UEB48-1 1/2-3	1.5	465	21731	19010	14991	7081	72	535
	UEB48-2	UEB48-2-3	2	520	24274	21943	19080	10125	74	545
	-----	UEB48-3-3	3	680	28150	25683	23615	16930	80	560
54"	UEB54-1	UEB54-1-3	1	410	23130	20588	17500	9600	73	870
	UEB54-1 1/2	UEB54-1 1/2-3	1.5	450	25400	22600	19300	10316	75	880
	UEB54-2	UEB54-2-3	2	480	27200	24312	20660	11010	76	890
	-----	UEB54-3-3	3	550	31213	28722	25830	15420	80	900
	-----	UEB54-5-3	5	660	37458	35238	32843	26538	82	920
60"	UEB60-1 1/2	UEB60-1 1/2-3	1.5	340	28068	23203	15624	8000	78	940
	UEB60-2	UEB60-2-3	2	390	32200	26710	17924	9380	80	960
	-----	UEB60-3-3	3	450	37183	32356	25324	15013	84	985
	-----	UEB60-5-3	5	540	44600	41232	35819	23237	86	1000

Note: Products listed in this section are custom built and subject to 100% cancellation/restocking charges

Dimensions

SIZE	MINIMUM ROOF HOLE SIZE (SQUARE)	WIND BAND OUTER DIMENSION	ROOF CURB OUTER DIMENSION (SQUARE)	WIND BAND HEIGHT
24"	34"	30"	39"	19"
30"	40"	36"	45"	22"
36"	46"	42"	51"	25"
42"	52"	48"	57"	27"
48"	58"	54"	63"	30"
54"	64"	60"	69"	36"
60"	70"	66"	75"	42"

Tubeaxial Direct Drive Duct Fans



Features

- Totally enclosed and explosion proof motors
- 1-Phase motors are field convertible 115V/230V
- 3-Phase motors are field convertible 230V/460V
- Motors are set to lower voltage at the factory unless a request is made at time of order to set them to the higher voltage
- Explosion proof motors are Class 1, Div 1, Group D and Class 2, Div 1, Groups F & G
- 14-gauge steel drum including mounting flanges
- Fan can be mounted to operate in any position
- Rugged cast aluminum blade, non-sparking
- 1 year limited warranty

Dimensions

SIZE	HOUSING INNER DIM.	HOUSING OUTER DIM.	BOLT HOLE CENTERS	HOUSING DEPTH
12"	12"	14"	13 1/8"	14"
18"	18"	20"	19 1/8"	14"
24"	24"	27"	25 3/4"	18"
27"	27"	30"	28 3/4"	18"
30"	30"	33"	31 3/4"	18"
34"	34"	37"	35 3/4"	18"
42"	42"	45"	43 9/16"	18"
48"	48"	51"	49 5/8"	18"

⚠ WARNING: This product can expose you to chemicals including nickel which is known to the State of California to cause cancer, and chromium, which is known to the State of California to cause birth defects and/or reproductive harm. For more information go to www.P65Warnings.ca.gov.

Options

- Companion flanges
- Fan guards
- Protective coating
- Access doors

Standard Models

BLADE SIZE	1-PHASE 115/230V	3-PHASE 230/460V	HP	RPM	BLADES	C.F.M - STATIC PRESSURE				Db's @ 10'	WT. (LBS)
	MFG MODEL NUMBER					0"	1/4"	1/2"	3/4"		
12"	TXD12-1/4	TXD12-1/4-3	1/4	1725	4	1180	520	----	----	77	40
	TXD12-1/2	TXD12-1/2-3	1/2	3450	4	1875	1400	1250	1100	82	45
	TXD12-3/4	TXD12-3/4-3	3/4	3450	6	2044	1920	1650	1500	83	45
18"	TXD18-1/4	TXD18-1/4-3	1/4	1725	4	3450	2500	----	----	74	55
	TXD18-1/3	TXD18-1/3-3	1/3	1725	6	3375	2600	1400	----	75	65
	TXD18-1/2	TXD18-1/2-3	1/2	1725	6	4150	3150	1700	----	77	65
	TXD18-1	TXD18-1-3	1	1725	6	4600	4080	3000	2100	80	70
24"	TXD24-1/4	TXD24-1/4-3	1/4	1725	2	5200	2820	----	----	80	95
	TXD24-1/3	TXD24-1/3-3	1/3	1140	6	4975	4250	2850	----	74	110
	TXD24-1/2	TXD24-1/2-3	1/2	1725	4	6510	5200	3100	1800	80	115
	TXD24-3/4	TXD24-3/4-3	3/4	1140	6	6900	6265	3300	----	74	125
	TXD24-1	TXD24-1-3	1	1725	6	7425	6350	5000	3300	82	120
	TXD24-2	TXD24-2-3	2	1725	6	9525	8810	7980	6960	84	120
27"	-----	TXD24-3-3	3	1725	6	10500	9500	8700	7800	86	130
	TXD27-1/2	TXD27-1/2-3	1/2	1725	4	7550	6000	4000	2000	86	125
	TXD27-1	TXD27-1-3	1	1725	4	9600	8400	7050	4800	86	155
	TXD27-2	TXD27-2-3	2	1725	6	11500	10700	9300	8000	86	165
30"	TXD30-1/2	TXD30-1/2-3	1/2	1725	4	8980	6300	4350	2300	86	130
	TXD30-3/4	TXD30-3/4-3	3/4	1140	6	10440	8750	6000	----	80	150
	TXD30-2	TXD30-2-3	2	1725	6	12000	10450	8700	6000	89	155
34"	-----	TXD30-3-3	3	1725	6	16000	14700	12900	10200	89	175
	TXD34-1 1/2	TXD34-1 1/2-3	1.5	1725	4	13350	10000	7300	----	88	175
	TXD34-2	TXD34-2-3	2	1725	4	14850	12100	8800	4000	89	200
	-----	TXD34-3-3	3	1140	3	19300	17230	14800	11614	86	250
	-----	TXD34-5-3	5	1725	6	21000	18900	17500	14850	91	220
36"	TXD36-2	TXD36-2-3	2	1140	6	17620	15200	12300	8500	84	210
	-----	TXD36-3-3	3	1725	4	18500	15700	13900	11500	89	230
42"	-----	TXD42-1-3	1	870	4	15800	13480	5800	900	81	270
	TXD42-2	TXD42-2-3	2	1140	4	17964	15326	12351	7600	87	260
	-----	TXD42-3-3	3	1140	4	24500	23000	19650	14000	87	260
	-----	TXD42-5-3	5	1140	4	28970	26840	24200	19500	87	300
48"	-----	TXD48-3-3	3	1140	4	28600	24400	20000	15900	94	290
	-----	TXD48-5-3	5	870	4	33000	29750	25300	18000	86	500

Duct Fan Guards

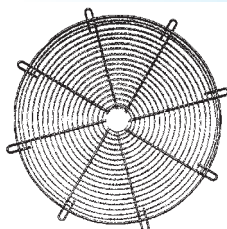

Features

- Enamel finish
- Can be used as front or rear guards. (Rear guard for TXD models must be ordered with fan)

⚠ WARNING: This product can expose you to chemicals including nickel which is known to the State of California to cause cancer, and chromium, which is known to the State of California to cause birth defects and/or reproductive harm. For more information go to www.P65Warnings.ca.gov.

Standard Models

FAN SIZE	MFG MODEL	FAN SIZE	MFG MODEL
12"	TXG-12	30"	TXG-30
15"	TXG-15	34"	TXG-34
18"	TXG-18	36"	TXG-36
24"	TXG-24	42"	TXG-42
27"	TXG-27	48"	TXG-48

Note: Products listed in this section are custom built and subject to 100% cancellation/restocking charges

Tubeaxial Belt Drive Duct Fans

Features

- Eliminates fumes and vapors from paint spray booths and other hazardous areas
- Totally enclosed and explosion proof motors
- 1-Phase motors are field convertible 115V/230V
- 3-Phase motors are field convertible 230V/460V
- Motors are set to lower voltage at the factory unless a request is made at time of order to set them to the higher voltage
- Explosion proof motors are Class 1, Div 1, Group D and Class 2, Div 1, Groups F & G
- Recommended for most paint spray applications because motor is out of air
- 14-gauge steel drum including mounting flanges at each end
- Completely enclosed belt and ball bearing housing
- Adjustable motor base for proper belt tension
- Rugged cast aluminum blade, non-sparking
- Fan can be mounted to operate in any position
- 1 year limited warranty

⚠WARNING: This product can expose you to chemicals including nickel which is known to the State of California to cause cancer, and chromium, which is known to the State of California to cause birth defects and/or reproductive harm. For more information go to www.P65Warnings.ca.gov.



Options

- Companion flanges
- Protective coating
- Access doors
- Belt guards
- Motor covers
- Fan guards

Standard Models

BLADE SIZE	1-PHASE 115/230V-60Hz	3-PHASE 230/460v-60Hz	HP	RPM	BLADES	C.F.M - STATIC PRESSURE				Db's @10'	WT (LBS)
	MFG MODEL NUMBER					0"	1/4"	1/2"	3/4"		
12"	TXB12-1/4	TXB12-1/4-3	1/4	2625	4	1444	1033	380	----	77	62
	TXB12-1/3	TXB12-1/3-3	1/3	2875	4	1586	1135	415	----	78	65
	TXB12-1/2	TXB12-1/2-3	1/2	3450	4	1875	1400	1250	1100	83	65
	TXB12-3/4	TXB12-3/4-3	3/4	3450	6	2044	1920	1650	1500	83	67
15"	TXB15-1/4	TXB15-1/4-3	1/4	2000	6	2600	1700		----	77	67
	TXB15-1/3	TXB15-1/3-3	1/3	2200	6	2950	2100	1000	----	78	69
	TXB15-1/2	TXB15-1/2-3	1/2	1890	6	3350	2650	1500	----	76	75
	TXB15-3/4	TXB15-3/4-3	3/4	2200	6	3900	3400	2700	1150	78	85
18"	TXB18-1/4	TXB18-1/4-3	1/4	1600	6	3050	2000		----	76	80
	TXB18-1/3	TXB18-1/3-3	1/3	1725	6	3375	2600	1400	----	77	85
	TXB18-1/2	TXB18-1/2-3	1/2	1890	6	3850	3100	2000	----	78	95
	TXB18-1	TXB18-1-3	1	1725	6	4600	4080	3000	2100	77	105
24"	TXB18-1 1/2	TXB18-1 1/2-3	1.5	1990	6	5350	4830	3950	3000	80	105
	TXB24-1/2	TXB24-1/2-3	1/2	1298	6	5643	4826	3500	----	78	120
	TXB24-3/4	TXB24-3/4-3	3/4	1600	6	6906	5900	4650	2750	80	130
	TXB24-1	TXB24-1-3	1	1725	6	7425	6350	5000	3300	84	140
	TXB24-1 1/2	TXB24-1 1/2-3	1.5	1540	6	8200	7650	6850	5500	81	145
	TXB24-2	TXB24-2-3	2	1600	6	9760	8830	8090	7000	82	170
27"	-----	TXB24-3-3	3	1725	6	10500	9500	8700	7800	86	190
	TXB27-3/4	TXB27-3/4-3	3/4	1250	6	8330	7550	6500	4650	78	150
	TXB27-1	TXB27-1-3	1	1400	6	9400	8480	7300	5200	82	155
	TXB27-1 1/2	TXB27-1 1/2-3	1.5	1600	6	10700	9700	8375	6000	84	170
30"	TXB27-2	TXB27-2-3	2	1350	6	11500	10700	9300	8000	81	210
	TXB30-1/2	TXB30-1/2-3	1/2	1140	4	8900	6660	2300	----	79	140
	TXB30-1	TXB30-1-3	1	1298	6	9867	7980	4120	----	82	150
	TXB30-1 1/2	TXB30-1 1/2-3	1.5	1035	6	11100	9700	7500	3500	78	165
	TXB30-2	TXB30-2-3	2	1176	6	12100	11000	9322	6700	81	215
	-----	TXB30-3-3	3	1350	6	13480	12498	11465	10380	84	215
34"	-----	TXB30-5-3	5	1650	6	16440	15242	13982	12659	88	230
	TXB34-1 1/2	TXB34-1 1/2-3	1.5	1170	6	13695	11100	6000	1015	82	190
	TXB34-2	TXB34-2-3	2	1027	6	14657	12590	10000	8000	81	240
	-----	TXB34-3-3	3	1175	6	17580	15896	14095	12000	85	260
42"	-----	TXB34-5-3	5	1416	6	20500	19000	17500	16000	88	305
	TXB42-1 1/2	TXB42-1 1/2-3	1.5	750	4	18960	14662	7200	----	78	250
	TXB42-2	TXB42-2-3	2	820	4	20700	17002	11400	4000	80	260
	-----	TXB42-3-3	3	890	4	23700	20200	16970	9950	82	260
48"	-----	TXB42-5-3	5	850	6	26900	24403	22250	18400	82	270
	-----	TXB48-5-3	5	800	6	33000	29000	25600	20000	85	375
	-----	TXB48-7 1/2-3	7.5	900	6	37000	34500	31000	27000	87	520

Dimensions

SIZE	HOUSING INNER DIMENSION	HOUSING OUTER DIMENSION	BOLT HOLE CENTERS	HOUSING DEPTH
12"	12"	14"	13 1/8"	12"
15"	15"	17"	16 1/8"	12"
18"	18"	20"	19 1/8"	12"
24"	24"	27"	25 3/4"	12" & 16"
27"	27"	30"	28 3/4"	16"
30"	30"	33"	31 3/4"	16"
34"	34"	37"	35 3/4"	16"
42"	42"	45"	43 1/16"	18"
48"	48"	51"	49 3/8"	24"

Note: Products listed in this section are custom built and subject to 100% cancellation/restocking charges

Belt Drive Wholehouse Fans

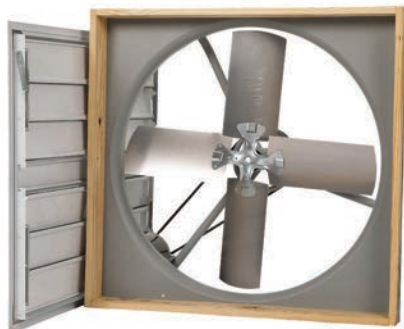

WARNING: This product can expose you to chemicals including nickel which is known to the State of California to cause cancer, and chromium, which is known to the State of California to cause birth defects and/or reproductive harm. For more information go to www.P65Warnings.ca.gov.



Features

- 120V 1-phase, 2-speed motor
- Shutters automatically open when fan is turned on and close tightly when fan is turned off.
- Made in the U.S.A.



FAN DIMENSIONS

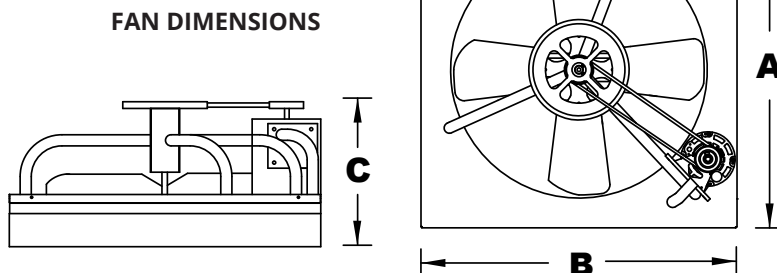

Standard Models

MFG CATALOG NUMBER	MFG MODEL NUMBER	SIZE	SPEED	MOTOR HP	CFM @ .1 IN. H2O PRESSURE DROP w/SHUTTER	FAN SPEED RPM	FAN MOUNTING DIMENSIONS (IN)			EXHAUST SQ. FT. REQ'D	AMPS	WT. (LBS)
							A	B	C			
07936202	BD24-2-WHS	24"	2	1/3	4500/2700	612/410	28	29.5	14.5	7	5.7/4.8	40
07936302	BD30-2-WHS	30"	2	1/3	7600/5800	520/350	34	35.5	14.5	9	6.9/5.5	50
07936402	BD36-2-WHS	36"	2	1/3	9675/6400	395/265	40	41.5	14.5	12	6.3/3.1	64

Ceiling Shutters

MFG CATALOG NUMBER	MFG MODEL NUMBER	FIT HOLE SIZE (I.D.)	OUTSIDE SIZE (O.D.)	FAN SIZE	WT. (LBS)
07944802	CS-10-W	26X26	28X28	24"	8
07944602	CS-13-W	32X34	34X36	30"	10
07945302	CS-14-W	34X34	36X36	30"	10
07944702	CS-18-W	32X43	34X45	36"	11
07945202	CS-19-W	34X43	36X45	36"	11

Control Options

MFG CATALOG NUMBER	MFG MODEL NUMBER	DESCRIPTION	WT. (LBS)
07927002	2-SW	2 speed wall switch & plate	1
05000802	1A22-7	SP close on rise (Attic Thermostat) (80°-130°F)	1

NOTE: "Joist out style" (For replacement only)

Loading Dock Lights - Shipped in (1) One Carton



DKL-40VA-A



Flexible elastomer arm moves when hit and then returns light to original position

DKL-25-FLX



LED 30-Watt
DKLED-40-30W

WARNING: This product can expose you to chemicals including nickel which is known to the State of California to cause cancer, and chromium, which is known to the State of California to cause birth defects and/or reproductive harm. For more information go to www.P65Warnings.ca.gov.

Product Features

- Chip resistant safety yellow & black powder coated finish for high visibility and durability
- 5' long 18/3 SJT, 120V cordset with NEMA 15-5 grounded plug
- On/Off switch & wire guard included on each light head
- 1-1/2" square, 11-gauge, steel tubing
- 3" x 5" x 3/16" mounting plate attached with (4) 3/8" bolts (not supplied)
- VA & DKLED models have vertical adjustment bracket allowing outer arm to adjust from 300° horizontally and 210° vertically
- All light heads will swivel 300°
- VA Models include an embedded electrical outlet for direct plug connection from the light head fixture and shipped fully-assembled
- DKLED units contain a die-cast aluminum light head with adjustable knobs, built-in on/off switch, and maintains an IP65 rating suitable for wet locations
- DKLED units use a 20° custom beam angle and 12 individual high-intensity LED emitters generating a neutral white color; with a CCT measuring 4,000K DKLED units provide a minimum life of 50,000 hours and offers a 5-year warranty, including CE & RoHS Certificates
- Designed for loading dock and work station environments
- ETL C/US Listed for indoor applications only, except QH models are semi-protected outdoor and DKLED models have IP65 rating suitable for wet location areas

Standard Models (120V)

MFG CATALOG NUMBER	MFG MODEL NUMBER	ARM LENGTH	# OF ARMS	MAX WATTS	WT. (LBS)
NO BULB					
04466502	DKL-40VA-A	40"	2	Maximum 300	14
04466602	DKL-60VA-A	60"	2		17
LED - 3,300 Lumens, 4,000K CCT, 50,000-hour Avg. Bulb Life					
04922802	DKLED-40-30W	40"	2	30	13
04922902	DKLED-42-30W	42"	3		14



Spot task lighting WHEN & WHERE you need it!



LED 30-Watt
DKLED-42-30W



Loading Dock Lights - Modular (shipped in multiple cartons)

Modular Lights

DKL-INC



DKL-LED-30W-SP



DKLED-30W-WP



Features

- 14" long, 18/3 conductor cord plugs into electrical junction box on arm
- On/off switch & wire guard included with each light head
- Bulb included with all light heads except DKL-INC
- Imported to TPI specifications.
- DKL-LED-37 is compliant with ROHS 2 Directive
- (2011/65/EU), that of which includes the application exemptions outlined in Annex III of the directive.



WARNING: This product can expose you to chemicals including nickel which is known to the State of California to cause cancer, and chromium, which is known to the State of California to cause birth defects and/or reproductive harm. For more information go to www.P65Warnings.ca.gov.

Standard Models

MFG CATALOG NUMBER	MFG MODEL NUMBER	LIGHT HEAD TYPE	MAX WATTS	MAX LUMENS	AVE. BULB LIFE (HRS)	WT. (LBS)
04465602	DKL-INC	Incandescent	300	3,700	2,000	5
04923002	DKLED-30W-WP	LED w/ Pin Connector Plug	30	3,300	50,000	7
04923102	DKLED-30W-SP	LED w/ Grounded Plug	30	3,300	50,000	7

Mounting Arms



DKL-40VA-ARM



60-LDAG



24-LDAG



The outer arm on 40VA & 60VA arms will swing 300° in horizontal plane & 210° in vertical plane

WARNING: This product can expose you to chemicals including nickel which is known to the State of California to cause cancer, and chromium, which is known to the State of California to cause birth defects and/or reproductive harm. For more information go to www.P65Warnings.ca.gov.

Features

- 1 1/2" square, 11 gauge, steel tubing
- 6GA CRS angle, 3" x 3" mounting plate attaches with (4) 3/8" bolts
- 5' long, 18/3 SJTW conductor cord and
- NEMA 5-15 grounded plug

Standard Models

MFG CATALOG NUMBER	MFG MODEL NUMBER	ARM LENGTH	TOTAL # OF ARMS	WT. (lbs)
04465402	DKL-40VA-ARM	40"	2	18
04465502	DKL-60VA-ARM	60"	2	24
04465302	24-LDA	24"	1	11
04466102	40-LDA**	40"	3	18
04466202	60-LDA**	60"	3	24

**Indicates heavy duty dock arms (horizontal swing only, no vertical movement)

Loading Dock Arm Fan



WARNING: This product can expose you to chemicals including nickel which is known to the State of California to cause cancer, and chromium, which is known to the State of California to cause birth defects and/or reproductive harm. For more information go to www.P65Warnings.ca.gov.

Features

- 18" high velocity circulator, with 3 speed, 1/8 HP, 115V,
- 1 phase permanently lubricated, totally enclosed, PSC motor
- Modular fan plugs into electrical outlet on arm
- Coated steel guards and aluminum blades
- Imported to TPI specifications

Standard Models

MFG CATALOG NUMBER	MFG MODEL NUMBER	CFM			VELOCITY PROFILE MAX. CFM	AMPS HIGH	WT. (LBS)
		HIGH	MED	LOW			
07971802	LDF-18-TE	1800	1500	1300	2900	2.2	20

Note: Must be used with LDA (Heavy Duty) mounting arms

Machine Tool Lights

Water Resistant Fluorescent or LED Tube Lights



29-LED



23-TLP-24VDC



21-LED

Features

- All tube lights come standard with a durable, lightweight, economical, shatter-resistant polycarbonate tube housing
- Stainless steel mounting brackets (2), fasteners and threaded conduit fitting included with all models
- LEDTLP Models are ETL C/US Listed for NEMA Type 13 applications - oil / water / coolant spray areas (not submersible) and dusty atmospheres
- LED Models operate at 120V and include an 8' long, 18/3 SJTOW cord with NEMA 5-15 grounded plug
- LED Models comply with part-15 of the FCC rule
- Model 21-LEDTLP-120-16 includes an aluminum enclosure with on/off power switch
- Model 21-LED generates 100 Watts of an incandescent light output equivalent, but only consumes 16 Watts of power; Model 29-LED generates 150 Watts, using only 26 Watts of power.
- 23-TLP-24VDC uses a fluorescent bulb and operates at low voltage of 24V DC, includes on board ballast and 2' long lead wires for direct connection; unit is NOT ETL Listed
- All units are made in the U.S.A.

Standard Models

MFG CATALOG NUMBER	MFG MODEL NUMBER	DESCRIPTION	WATTS	VOLTS	LUMENS	OVERALL LENGTH	TUBE MATERIAL	BALLAST INCLUDED	WT. (LBS)
04829302	23-TLP-24VDC**	Fluorescent, w/wire leads	18	24VDC	1250	23"	Polycarbonate	Yes	6
04891802	21-LEDTLP-120-16	LED, on/off switch enclosure & cordset	16	120V	1200	21"	Polycarbonate	No	4
04891902	29-LEDTLP-120-26	LED w/cordset	26	120V	2800	29"	Polycarbonate	No	3

Accessories - Replacement Lamps

MFG CATALOG NUMBER	MFG MODEL NUMBER	DESCRIPTION	USED WITH	WT. (LBS)
3103300	TL-RB-18	Fluorescent Replacement Bulb, 18W, PL-L	23-TLP-24VDC	1

WARNING: This product can expose you to chemicals including nickel which is known to the State of California to cause cancer, and chromium, which is known to the State of California to cause birth defects and/or reproductive harm. For more information go to www.P65Warnings.ca.gov.



MODEL	PAGE	MODEL	PAGE	MODEL	PAGE	MODEL	PAGE
1A22-7	41	CACU 24-W	8	CE 30-D	24	CESM-36	32
2-SW	41	CACU 24-WO	8	CE 30-DS	23	CESM-42	32
21-LEDTLP-120-16	44	CACU 30-P	8	CE 30-DV	25	CESM-48	32
29-LEDTLP-120-26	44	CACU 30-P-HD	8	CE-24B	26	CESM-60	32
23-TLP-24VDC	44	CACU 30-PO	8	CE-24B-3	26	CF-12	20
24-LDA	43	CACU 30-PO-HD	8	CE-30B	26	CF-18	20
24-LDF-TE	21	CACU 30-W	8	CE-30B-3	26	CF-20	20
40-LDA	43	CACU 30-WO	8	CE-36B	26	CL-300	44
40-LDF-TE	21	CAS - 18	16	CE-36B-3	26	CPB 30-D	9
60-LDA	43	CAS - 48	16	CE-42B	26	CPB 36-B	9
60-LDF-TE	21	CBT-24B	30	CE-42-B-3	26	CPB 36-D	9
ACH 20	3	CBT-24B-3	31	CE-48B	26	CPB 42-B	9
ACH 20-O	3	CBT-30B	31	CE-48-B-3	26	CPB 48-B	9
ACH 24	3	CBT-30B-3	31	CEFP-12	34	CPBS 24-DHV	9
ACH 24-EX1	5	CBT-36B	31	CEFP-16	34	CPBS 30-D	9
ACH 24-EX3	5	CBT-36B-3	31	CEFP-18	34	CS-10-W	41
ACH 24-O	3	CBT-42B	31	CEFP-20	34	CS-13-W	41
ACH 24-TE3	5	CBT-42B-3	31	CEFP-24	34	CS-14-W	41
ACH 30-TE3	5	CBT-48B	31	CEFP-30	34	CS-18-W	41
ACH 30	3	CBT-48B-3	31	CEFP-36	34	CS-19-W	41
ACH 30-EX1	5	CD-18	35	CEFP-42	34	DKL-25-FLX	42
ACH 30-EX3	5	CD-24	35	CEFP-48	34	DKL-40VA-A	42
ACH 30-O	3	CD-30	35	CEFP-60	34	DKL-40VA-ARM	43
ACM-C	6	CD-36	35	CES 12-HD	32	DKL-60VA-A	42
ACM-I	6	CD-42	35	CES 16-HD	32	DKL-60VA-ARM	43
ACM-P	6	CD-48	35	CES 18-HD	32	DKL-INC	21, 43
ACM-PM	6	CD-54	35	CES 20-HD	32	DKLED-30W-WP	43
ACM-S	6	CD-60	35	CES 24-HD	32	DKLED-30W-SP	43
ACM-W	6	CE 10-D	24	CES 30-HD	32	DKLED-40-30W	42
ACM-WK	6	CE 10-DS	23	CES 36-HD	32	DKLED-42-30W	42
ACU 20-P	4	CE 10-DV	25	CES 42-HD	32	DKL-LED-37	43
ACU 20-PO	4	CE 12-D	24	CES 48-HD	32	DKL-QH	21, 43
ACU 20-W	4	CE 12-DS	23	CES 54-HD	32	DMKP1	34
ACU 20-WO	4	CE 12-DV	25	CES 60-HD	33	DMKP2	35
ACU 24-P	4	CE 14-D	25	CES-10G	24, 25	DR36	24
ACU 24-PO	4	CE 14-DS	23	CES-12G	24, 25	E-56CF	22
ACU 24-W	4	CE 14-DV	25	CES-14G	24, 25	E-60CF	22
ACU 24-WO	4	CE 16-D	24	CES-16G	24, 25	E-60CFC	22
ACU 30-P	4	CE 16-DS	23	CES-18G	24, 25	EHB24-1	30
ACU 30-PO	4	CE 16-DV	25	CES-20G	24, 25	EHB24-1-3	30
ACU 30-W	4	CE 18-D	24	CES-24	26	EHB24-1/2	30
ACU 30-WO	4	CE 18-DS	23	CES-24G	24, 25	EHB24-1/2-3	30
BD24-2-WHS	41	CE 18-DV	25	CES-30	26	EHB24-1/4	30
BD30-2-WHS	41	CE 20-D	24	CES-30G	24, 25	EHB24-1/4-3	30
BD36-2-WHS	41	CE 20-DS	23	CES-36	26	EHB24-3/4	30
CACU 20-P	8	CE 20-DV	25	CES-42	26	EHB24-3/4-3	30
CACU 20-W	8	CE 24-D	24	CES-48	26	EHB30-1	30
CACU 24-P	8	CE 24-DS	23	CESM-24	32	EHB30-1 1/2	30
CACU 24-PO	8	CE 24-DV	25	CESM-30	32	EHB30-1 1/2-3	30

Product Index Listing

46

INDEX

MODEL	PAGE	MODEL	PAGE	MODEL	PAGE	MODEL	PAGE
1A22-7	41	CACU 24-W	8	CE 30-D	24	CESM-36	32
2-SW	41	CACU 24-WO	8	CE 30-DS	23	CESM-42	32
21-LEDTLP-120-16	44	CACU 30-P	8	CE 30-DV	25	CESM-48	32
29-LEDTLP-120-26	44	CACU 30-P-HD	8	CE-24B	26	CESM-60	32
23-TLP-24VDC	44	CACU 30-PO	8	CE-24B-3	26	CF-12	20
24-LDA	43	CACU 30-PO-HD	8	CE-30B	26	CF-18	20
24-LDF-TE	21	CACU 30-W	8	CE-30B-3	26	CF-20	20
40-LDA	43	CACU 30-WO	8	CE-36B	26	CL-300	44
40-LDF-TE	21	CAS - 18	16	CE-36B-3	26	CPB 30-D	9
60-LDA	43	CAS - 48	16	CE-42B	26	CPB 36-B	9
60-LDF-TE	21	CBT-24B	30	CE-42-B-3	26	CPB 36-D	9
ACH 20	3	CBT-24B-3	31	CE-48B	26	CPB 42-B	9
ACH 20-O	3	CBT-30B	31	CE-48-B-3	26	CPB 48-B	9
ACH 24	3	CBT-30B-3	31	CEFP-12	34	CPBS 24-DHV	9
ACH 24-EX1	5	CBT-36B	31	CEFP-16	34	CPBS 30-D	9
ACH 24-EX3	5	CBT-36B-3	31	CEFP-18	34	CS-10-W	41
ACH 24-O	3	CBT-42B	31	CEFP-20	34	CS-13-W	41
ACH 24-TE3	5	CBT-42B-3	31	CEFP-24	34	CS-14-W	41
ACH 30-TE3	5	CBT-48B	31	CEFP-30	34	CS-18-W	41
ACH 30	3	CBT-48B-3	31	CEFP-36	34	CS-19-W	41
ACH 30-EX1	5	CD-18	35	CEFP-42	34	DKL-25-FLX	42
ACH 30-EX3	5	CD-24	35	CEFP-48	34	DKL-40VA-A	42
ACH 30-O	3	CD-30	35	CEFP-60	34	DKL-40VA-ARM	43
ACM-C	6	CD-36	35	CES 12-HD	32	DKL-60VA-A	42
ACM-I	6	CD-42	35	CES 16-HD	32	DKL-60VA-ARM	43
ACM-P	6	CD-48	35	CES 18-HD	32	DKL-INC	43
ACM-PM	6	CD-54	35	CES 20-HD	32	DKLED-30W-WP	43
ACM-S	6	CD-60	35	CES 24-HD	32	DKLED-30W-SP	43
ACM-W	6	CE 10-D	24	CES 30-HD	32	DKLED-40-30W	42
ACM-WK	6	CE 10-DS	23	CES 36-HD	32	DKLED-42-30W	42
ACU 20-P	4	CE 10-DV	25	CES 42-HD	32	DKL-QH	21, 43
ACU 20-PO	4	CE 12-D	24	CES 48-HD	32	DMKP1	34
ACU 20-W	4	CE 12-DS	23	CES 54-HD	32	DMKP2	35
ACU 20-WO	4	CE 12-DV	25	CES 60-HD	33	DR36	24
ACU 24-P	4	CE 14-D	25	CES-10G	24, 25	E-56CF	22
ACU 24-PO	4	CE 14-DS	23	CES-12G	24, 25	E-60CF	22
ACU 24-W	4	CE 14-DV	25	CES-14G	24, 25	E-60CFC	22
ACU 24-WO	4	CE 16-D	24	CES-16G	24, 25	EHB24-1	30
ACU 30-P	4	CE 16-DS	23	CES-18G	24, 25	EHB24-1-3	30
ACU 30-PO	4	CE 16-DV	25	CES-20G	24, 25	EHB24-1/2	30
ACU 30-W	4	CE 18-D	24	CES-24	26	EHB24-1/2-3	30
ACU 30-WO	4	CE 18-DS	23	CES-24G	24, 25	EHB24-1/4	30
BD24-2-WHS	41	CE 18-DV	25	CES-30	26	EHB24-1/4-3	30
BD30-2-WHS	41	CE 20-D	24	CES-30G	24, 25	EHB24-3/4	30
BD36-2-WHS	41	CE 20-DS	23	CES-36	26	EHB24-3/4-3	30
CACU 20-P	8	CE 20-DV	25	CES-42	26	EHB30-1	30
CACU 20-W	8	CE 24-D	24	CES-48	26	EHB30-1 1/2	30
CACU 24-P	8	CE 24-DS	23	CESM-24	32	EHB30-1 1/2-3	30
CACU 24-PO	8	CE 24-DV	25	CESM-30	32	EHB60-2	30

MODEL	PAGE	MODEL	PAGE	MODEL	PAGE	MODEL	PAGE
EHB30-1-3	30	EHB60-1-3	30	EHD42-1-3	29	HV-3	15
EHB30-1/2	30	EHB60-2	30	EHD42-2	29	HV-4-18	15
EHB30-1/2-3	30	EHB60-2-3	30	EHD42-2-3	29	HV-4-24	15
EHB30-1/3	30	EHB60-3-3	30	EHD42-3-3	29	HV-4-30	15
EHB30-1/3-3	30	EHB60-5-3	30	EHD42-5-3	29	HV-5-18	15
EHB30-1/4	30	EHD12-1/4	29	EHD48-3-3	29	HV-5-24	15
EHB30-1/4-3	30	EHD12-1/4-3	29	EHD48-5-3	29	HV-5-30	15
EHB30-3/4	30	EHD16-1/4	29	EHD60-10-3	29	HV-6-18	15
EHB30-3/4-3	30	EHD16-1/4-3	29	EHD60-3-3	29	HV-6-24	15
EHB36-1	30	EHD18-1/2	29	EHD60-5-5	29	HV-6-30	15
EHB36-1 1/2	30	EHD18-1/2-3	29	EHD60-7 1/2-3	29	HV-7-DC-1	15
EHB36-1 1/2-3	30	EHD18-1/3	29	EMF-12	33	HV-7-DC-3	15
EHB36-1-3	30	EHD18-1/3-3	29	EMF-16	33	HV-8	15
EHB36-1/2	30	EHD20-1	29	EMF-20	33	HV18-120V	15
EHB36-1/2-3	30	EHD20-1-3	29	EMF-24	33	HV18-208/240V	15
EHB36-1/3	30	EHD20-1/2	29	EMF-30	33	HV18-277V	15
EHB36-1/3-3	30	EHD20-1/2-3	29	EMF-36	33	HV18-480V	15
EHB36-2	30	EHD20-1/4	29	EMF-42	33	HV24-120V	15
EHB36-2-3	30	EHD20-1/4-3	29	EMF-48	33	HV24-208/240V	15
EHB36-3/4	30	EHD24-1	29	EMF-60	3	HV24-277V	15
EHB36-3/4-3	30	EHD24-1-3	29	F-12-TE	18	HV24-480V	15
EHB42-1	30	EHD24-1/2	29	F-18-TE	18	HV30-120V	15
EHB42-1 1/2	30	EHD24-1/2-3	29	F-18H-TE	18	HV30-208/240V	15
EHB42-1 1/2-3	30	EHD24-1/3	29	F-24-TE	18	HV30-277V	15
EHB42-1-3	30	EHD24-1/3-3	29	F-24-TE-HV	18	HV30-480V	15
EHB42-1/2	30	EHD24-1/4	29	F-24H-TE	18	HV18-480V-3	15
EHB42-1/2-3	30	EHD24-1/4-3	29	FLS-18	34	HV24-480V-3	15
EHB42-1/3	30	EHD24-2	29	FLS-24	35	HV30-480V-3	15
EHB42-1/3-3	30	EHD24-2-3	29	FLS-30	35	HV-34-480V-3	15
EHB42-2	30	EHD24-3-3	29	FLS-36	35	HV-4-34	15
EHB42-2-3	30	EHD24-3/4	29	FLS-42	35	HV-3-34	15
EHB42-3-3	30	EHD24-3/4-3	29	FLS-48	35	IBG-12	33
EHB42-3/4	30	EHD30-1 1/2	29	FLS-54	35	IBG-16	33
EHB42-3/4-3	30	EHD30-1 1/2-3	29	FLS-60	35	IBG-18	33
EHB48-1	30	EHD30-1-3	29	HDH 24	2	IBG-20	33
EHB48-1 1/2	30	EHD30-1/2	29	HDH 24-G	3	IBG-24	33
EHB48-1 1/2-3	30	EHD30-1/2-3	29	HDH 24-GJR	3	IBG-30	33
EHB48-1-3	30	EHD30-1/3	29	HDH 24-JR	2	IBG-36	33
EHB48-1/2	30	EHD30-1/3-3	29	HDH 30	2	IBG-42	33
EHB48-1/2-3	30	EHD30-2	29	HDH 30-G	3	IBG-48	33
EHB48-2	30	EHD30-2-3	29	HDH 30-GJR	3	IBG-60	33
EHB48-2-3	30	EHD30-3-3	29	HDH 30-JR	2	IE24-1	28
EHB48-3-3	30	EHD30-3/4	29	HDH 36	3	IE24-1-3	28
EHB48-3/4	30	EHD30-3/4-3	29	HDM-C	6	IE24-1/2	28
EHB48-3/4-3	30	EHD36-1	29	HDM-I	6	IE24-1/2-3	28
EHB48-5-3	30	EHD36-1-3	29	HDM-P	6	IE24-1/3	28
EHB60-1	30	EHD36-2-3	29	HDM-W	6	IE24-1/3-3	28
EHB60-1 1/2	30	EHD36-3-3	29	HV-1	15	IE24-3/4	28
EHB60-1 1/2-3	30	EHD36-5-3	29	HV-2	15	IE24-3/4-3	28

Product Index Listing

48

INDEX

MODEL	PAGE	MODEL	PAGE	MODEL	PAGE	MODEL	PAGE
IE30-1	28	IED20-3/4	27	MCD48-10	16	QH-2	43
IE30-1-3	28	IED20-3/4-3	27	MCD48-5	16	RDS-18	35
IE30-1/2	28	IED24-1	27	MCD48-7 1/2	16	RDS-24	35
IE30-1/2-3	28	IED24-1-3	27	MCD60-10	16	RDS-30	35
IE30-1/3	28	IED30-1	27	MCD60-15	16	RDS-36	35
IE30-1/3-3	28	IED30-1-3	27	MCD60-3	16	RDS-42	35
IE30-3/4	28	IED36-1 1/2	27	MCD60-5	16	RDS-48	35
IE30-3/4-3	28	IED36-1 1/2-3	27	MCD60-7 1/2	16	RDS-54	35
IE36-1	28	IED42-2-3	27	MK-1	32	RDS-60	35
IE36-1 1/2	28	IED48-3-3	27	MK-2	32	RE24-1	36
IE36-1 1/2-3	28	IHP 20-H-WD	5	MK-3	32	RE24-1-3	36
IE36-1-3	28	IHP 24-H	3	N-12	21	RE24-1/2	36
IE36-1/2	28	IHP 24-H-277	5	ODF-12	20	RE24-1/2-3	36
IE36-1/2-3	28	IHP 24-H-WD	5	ODF-16	20	RE24-1/4	36
IE36-1/3	28	IHP 30-H	3	OSF-16	20	RE24-1/4-3	36
IE36-1/3-3	28	IHP 30-H-277	5	PBX 30-D	10	RE24-3/4	36
IE36-2	28	IHP 30-H-WD	5	PBX 36-B	11	RE24-3/4-3	36
IE36-2-3	28	KBWC-110K	22	PB 36-B-3	11	RE30-1	36
IE36-3/4	28	KBWC-15SK	22	PB 36-B-HL	11	RE30-1 1/2	36
IE36-3/4-3	28	LDF-18-TE	21, 43	PBX 36-D	10	RE30-1 1/2-3	36
IE42-1	28	MB 24-DF	13	PBX 42-B	11	RE30-1-3	36
IE42-1 1/2	28	MB 24-DY	13	PB 42-B-3	11	RE30-1/2	36
IE42-1 1/2-3	28	MB 30-DF	13	PB 42-B-HL	11	RE30-1/2-3	36
IE42-1-3	28	MB 30-DY	13	PBX 42-D	10	RE30-1/3	36
IE42-2	28	MBM-W	13	PBX 48-B	11	RE30-1/3-3	36
IE42-2-3	28	MCD18-1	16, 17	PB 48-B-3	11	RE30-3/4	36
IE42-3-3	28	MCD18-1/3	16, 17	PB 48-B-HL	11	RE30-3/4-3	36
IE42-3/4	28	MCD18-1/4	16, 17	PB 48-D-OP	10	RE36-1	36
IE42-3/4-3	28	MCD24-1	16, 17	PBSX 30-D	10	RE36-1 1/2	36
IE48-1	28	MCD24-1 1/2	16, 17	PBSX 36-B	11	RE36-1 1/2-3	36
IE48-1 1/2	28	MCD24-1/2	16, 17	PBS 36-B-3	11	RE36-1-3	36
IE48-1 1/2-3	28	MCD24-1/3	16, 17	PBS 36-B-HL	11	RE36-1/2	36
IE48-1-3	28	MCD24-1/4	16, 17	PBSX 36-D	10	RE36-1/2-3	36
IE48-2	28	MCD24-3	16, 17	PBSX 42-B	11	RE36-1/3	36
IE48-2-3	28	MCD24-3/4	16, 17	PBS 42-B-3	11	RE36-1/3-3	36
IE48-3-3	28	MCD30-1	16, 17	PBS 42-B-HL	11	RE36-2	36
IE48-3/4	28	MCD30-1 1/2	16, 17	PBSX 42-D	10	RE36-2-3	36
IE48-3/4-3	28	MCD30-1/2	16, 17	PBSX 48-B	11	RE36-3/4	36
IE48-5-3	28	MCD30-1/3	16, 17	PBS 48-B-3	11	RE36-3/4-3	36
IE60-2	28	MCD30-2	16, 17	PBS 48-B-HL	11	RE42-1	36
IE60-2-3	28	MCD30-3	16, 17	PBS 48-D-OP	10	RE42-1 1/2	36
IE60-3-3	28	MCD30-3/4	16, 17	PCBT 36-B	13	RE42-1 1/2-3	36
IE60-5-3	28	MCD36-1	16, 17	PCBT 42-B	13	RE42-1-3	36
IED12-1/4	27	MCD36-1 1/2	16, 17	PCBT 48-B	13	RE42-1/2	36
IED12-1/4-3	27	MCD36-2	16, 17	PM-1	19	RE42-1/2-3	36
IED16-1/3	27	MCD36-3	16, 17	PM-1.5	19	RE42-2	36
IED16-1/3-3	27	MCD36-5	16, 17	PM-2	19	RE42-2-3	36
IED18-1/2	27	MCD42-2	16	PM-2.5	19	RE42-3-3	36
IED18-1/2-3	27	MCD42-5	16	PM-3	19	RE42-3/4	36

MODEL	PAGE	MODEL	PAGE	MODEL	PAGE	MODEL	PAGE
RE42-3/4-3	36	SLS-42	35	TXB24-1 1/2	40	TXD18-1-3	38
RE48-1	36	SLS-48	35	TXB24-1 1/2-3	40	TXD18-1/2	38
RE48-1 1/2	36	SLS-54	35	TXB24-1-3	40	TXD18-1/2-3	38
RE48-1 1/2-3	36	SLS-60	35	TXB24-1/2	40	TXD18-1/3	38
RE48-1-3	36	SR-12	33	TXB24-1/2-3	40	TXD18-1/3-3	38
RE48-2	36	SR-16	33	TXB24-2	40	TXD18-1/4	38
RE48-2-3	36	SR-18	33	TXB24-2-3	40	TXD18-1/4-3	38
RE48-3-3	36	SR-20	33	TXB24-3-3	40	TXD24-1	38
RE48-3/4	36	SR-24	33	TXB24-3/4	40	TXD24-1-3	38
RE48-3/4-3	36	SW-1	16	TXB24-3/4-3	40	TXD24-1/2	38
RE48-5-3	36	SW-1 1/2	16	TXB27-1	40	TXD24-1/2-3	38
RE54-1	36	SW-1 1/2-3	16	TXB27-1 1/2	40	TXD24-1/3	38
RE54-1 1/2	36	SW-1-3	16	TXB27-1 1/2-3	40	TXD24-1/3-3	38
RE54-1 1/2-3	36	SW-1/2	16	TXB27-1-3	40	TXD24-1/4	38
RE54-1-3	36	SW-1/2-3	16	TXB27-2	40	TXD24-1/4-3	38
RE54-2	36	SW-1/4	16	TXB27-2-3	40	TXD24-2	38
RE54-2-3	36	SW-1/4-3	16	TXB27-3/4	40	TXD24-2-3	38
RE54-3-3	36	SW-2-3	16	TXB27-3/4-3	40	TXD24-3-3	38
RE54-5-3	36	SW-3-3	16	TXB30-1	40	TXD24-3/4	38
RE60-1	36	SW-5-3	16	TXB30-1 1/2	40	TXD24-3/4-3	38
RE60-1 1/2	36	SW-7 1/2-3	16	TXB30-1 1/2-3	40	TXD27-1	38
RE60-1 1/2-3	36	TL-RB-18	44	TXB30-1-3	40	TXD27-1-3	38
RE60-1-3	36	TXB12-1/2	40	TXB30-1/2	40	TXD27-1/2	38
RE60-2	36	TXB12-1/2-3	40	TXB30-1/2-3	40	TXD27-1/2-3	38
RE60-2-3	36	TXB12-1/3	40	TXB30-2	40	TXD27-2	38
RE60-3-3	36	TXB12-1/3-3	40	TXB30-2-3	40	TXD27-2-3	38
RE60-5-3	36	TXB12-1/4	40	TXB30-3-3	40	TXD30-1/2	38
RE60-7 1/2-3	36	TXB12-1/4-3	40	TXB30-5-3	40	TXD30-1/2-3	38
SBX 30-D	12	TXB12-3/4	40	TXB34-1 1/2	40	TXD30-2	38
SBX 36-B	12	TXB12-3/4-3	40	TXB34-1 1/2-3	40	TXD30-2-3	38
SB 36-B-3	12	TXB15-1/2	40	TXB34-2	40	TXD30-3-3	38
SB 36-B-HL	12	TXB15-1/2-3	40	TXB34-2-3	40	TXD30-3/4	38
SBX 36-D	12	TXB15-1/3	40	TXB34-3-3	40	TXD30-3/4-3	38
SBX 42-B	12	TXB15-1/3-3	40	TXB34-5-3	40	TXD34-1 1/2	38
SB 42-B-3	12	TXB15-1/4	40	TXB42-1 1/2	40	TXD34-1 1/2-3	38
SB 42-B-HL	12	TXB15-1/4-3	40	TXB42-1 1/2-3	40	TXD34-2	38
SBX 42-D	12	TXB15-3/4	40	TXB42-2	40	TXD34-2-3	38
SBX 48-B	12	TXB15-3/4-3	40	TXB42-2-3	40	TXD34-3-3	38
SB 48-B-3	12	TXB18-1	40	TXB42-3-3	40	TXD34-5-3	38
SB 48-B-HL	12	TXB18-1 1/2	40	TXB42-5-3	40	TXD36-2	38
SF-12	33	TXB18-1 1/2-3	40	TXB48-5-3	40	TXD36-2-3	38
SF-16	33	TXB18-1-3	40	TXB48-7 1/2-3	40	TXD36-3-3	38
SF-18	33	TXB18-1/2	40	TXD12-1/2	38	TXD42-1-3	38
SF-20	33	TXB18-1/2-3	40	TXD12-1/2-3	38	TXD42-2	38
SF-24	33	TXB18-1/3	40	TXD12-1/4	38	TXD42-2-3	38
SLS-18	35	TXB18-1/3-3	40	TXD12-1/4-3	38	TXD42-3-3	38
SLS-24	35	TXB18-1/4	40	TXD12-3/4	38	TXD42-5-3	38
SLS-30	35	TXB18-1/4-3	40	TXD12-3/4-3	38	TXD48-3-3	38
SLS-36	35	TXB24-1	40	TXD18-1	38	TXD48-5-3	38

Product Index Listing

50

INDEX

MODEL	PAGE	MODEL	PAGE	MODEL	PAGE	MODEL	PAGE
TXG-24	38	UEB48-3/4	37	UED48-7 1/2-3	36		
TXG-27	38	UEB48-3/4-3	37	UED60-5-3	36		
TXG-30	38	UEB54-1	37	UED60-7 1/2-3	36		
TXG-34	38	UEB54-1 1/2	37	UHP 24-P	4		
TXG-36	38	UEB54-1 1/2-3	37	UHP 24-PJR	4		
TXG-42	38	UEB54-1-3	37	UHP 24-W	4		
TXG-48	38	UEB54-2	37	UHP 24-WJR	4		
U-12-TE	37	UEB54-2-3	37	UHP 30-IJR	4		
U-18-TE	19	UEB54-3-3	37	UHP 30-P	4		
U-18-TE-HD	19	UEB54-5-3	37	UHP 30-PJR	4		
U-24-TE	19	UEB60-1 1/2	37	UHP 30-W	4		
U-24-TE-HD	19	UEB60-1 1/2-3	37	UHP 30-WJR	4		
U-24-TE-HV	19	UEB60-2	37	WACM-P	6		
UEB24-1/2	37	UEB60-2-3	37	WACM-W	6		
UEB24-1/2-3	37	UEB60-3-3	37	WH-12	34		
UEB24-1/3	37	UEB60-5-3	37	WH-16	34		
UEB24-1/3-3	37	UED18-1	36	WH-18	34		
UEB24-3/4	37	UED18-1-3	36	WH-20	34		
UEB24-3/4-3	37	UED18-1/2	36	WH-24	34		
UEB30-1	37	UED18-1/2-3	36	WH-30	34		
UEB30-1-3	37	UED18-1/3	36	WH-36	34		
UEB30-1/2	37	UED18-1/3-3	36	WH-42	34		
UEB30-1/2-3	37	UED18-1/4	36	WH-48	34		
UEB30-3/4	37	UED18-1/4-3	36	WH-60	34		
UEB30-3/4-3	37	UED24-1	36				
UEB36-1	37	UED24-1-3	36				
UEB36-1 1/2	37	UED24-1/4	36				
UEB36-1 1/2-3	37	UED24-1/4-3	36				
UEB36-1-3	37	UED24-3-3	36				
UEB36-1/2	37	UED24-3/4	36				
UEB36-1/2-3	37	UED24-3/4-3	36				
UEB36-3/4	37	UED30-1 1/2	36				
UEB36-3/4-3	37	UED30-1 1/2-3	36				
UEB42-1	37	UED30-1-3	36				
UEB42-1 1/2	37	UED30-2	36				
UEB42-1 1/2-3	37	UED30-2-3	36				
UEB42-1-3	37	UED30-3-3	36				
UEB42-2	37	UED30-3/4	36				
UEB42-2-3	37	UED30-3/4-3	36				
UEB42-3-3	37	UED36-2	36				
UEB42-3/4	37	UED36-2-3	36				
UEB42-3/4-3	37	UED36-3-3	36				
UEB48-1	37	UED36-5-3	36				
UEB48-1 1/2	37	UED42-2	36				
UEB48-1 1/2-3	37	UED42-2-3	36				
UEB48-1-3	37	UED42-5-3	36				
UEB48-2	37	UED48-10-3	36				
UEB48-2-3	37	UED48-3-3	36				
UEB48-3-3	37	UED48-5-3	36				